

2016-19 Chevrolet Camaro SS

2017-19 Chevrolet Camaro ZL1

6.2L

CORSA[®]
PERFORMANCE



IMPORTANT! WARRANTY AND INSTALLATION INSTRUCTIONS

Please Forward All Information to Consumer

Be sure to review the enclosed instructions prior to beginning the installation process. If you have any questions about the enclosed parts or instructions, or if you encounter a problem during installation:

CALL TECHNICAL SUPPORT: 440.891.0999 or 800.486.0999

**TO ACTIVATE YOUR WARRANTY GO TO:
CORSAPERFORMANCE.COM/WARRANTY**

COLOR INSTRUCTIONS ARE AVAILABLE BY PART NUMBER ON: CORSAPERFORMANCE.COM



NEVER work on a hot exhaust system.
Allow time for the vehicle to cool.

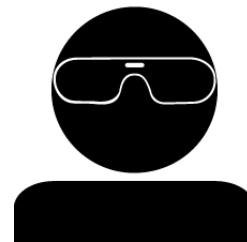

**Always wear eye protection
when working under a vehicle.**

INSTALL DIFFICULTY 

RECOMMENDED TOOLS & SUPPLIES

- 3/8" Drive Ratchet
- 3/8" Drive Torque Wrench
- 3/8" Drive 15mm Deep Socket
- Tape Measure & Permanent Marker
- Safety Glasses
- Soap & Water Solution
- 1/4" Drive Ratchet
- 1/4" Drive 8mm Socket
- Grommet Pullers
- Saw or Chain-style Pipe Cutter
- File or Sanding Device for De-burring

Please take time to read and understand these installation instructions.

CORSA recommends that the installation of this system be performed by a qualified service center or professional installer who has the necessary equipment, tools, and experienced personnel. However, if you decide to perform this installation yourself, the use of an additional person may be required.

WARNING: Never work on a hot exhaust system. Allow time for the vehicle to cool. Always wear eye protection when working under a vehicle.

CORSA Performance makes no representation or warranty, expressed or implied that its downpipe or header products and or components there-in comply with federal, state or local emission levels, noise levels, or safety standards or that any of their parts conform with the racing vehicles exemption, unless otherwise noted. The purchaser assumes all responsibility for such use and compliance.

This warranty does not extend to damaged or defect in the finish of a product or to any product, that in the opinion of CORSA Performance, has been misused, damaged by accident or negligence, altered or modified in any way, faulty installation or installed contrary to CORSA installation instructions, or repaired by an unauthorized service facility.

Full warranty available on www.corsaperformance.com

Please confirm that all parts are present according to the bill of materials before beginning the installation.

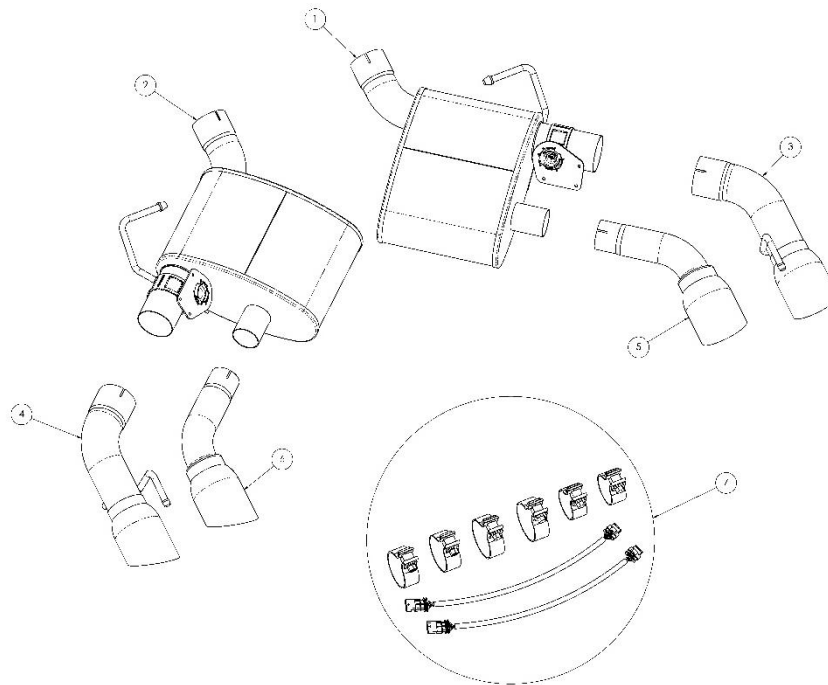

BILL OF MATERIALS

1.	Passenger Muffler Assembly (16CM2012)	2.	Driver Muffler Assembly (16CM2013)
3.	Passenger Outer Tip Assembly (16CM3004)	4.	Driver Outer Tip Assembly (16CM3005)
5.	Passenger Inner Tip Assembly (16CM3006)	6.	Driver Inner Tip Assembly (16CM3007)
7.	Hardware Kit (16CM7014)		

If something is missing call Tech Support at 440.891.099 or Toll Free: 1.800.486.0999

CAUTION: Never work on a hot exhaust system. Allow the vehicle to cool for at least an hour and a half. Always wear eye protection when working under a vehicle. It is recommended to use cotton gloves in order to protect stainless steel surfaces from permanent grease and oil stains.

REMOVAL INSTRUCTIONS

FACTORY EXHAUST



- 1.** Disconnect the driver and passenger rear NPP (non-AFM) valve plugs located near each of the outer stock exhaust tips.



- 2.** Measure 8 $\frac{3}{4}$ " away from the rear muffler case along the underside of the pipe towards the front of the vehicle. Scribe the pipe with a marker at the measured point to create a cut line.



- 3.** Repeat this measurement on the driver side pipe. Using a chain cutter or similar device, cut both the driver and passenger side exhaust pipes at the marked locations. Support the stock rear muffler using a jack stand or similar device.



- 4.** Using a 3/8" drive ratchet and 15mm socket, remove the two mounting nuts on each side (4 total) that hold the rear driver and passenger hanger grommet assemblies to the chassis.
NOTE: Save the mounting nuts for installation.

Continued on Next Page ...

REMOVAL INSTRUCTIONS

FACTORY EXHAUST



- 5.** Remove the two front hangers on each side from the factory grommets using a grommet puller or similar device.
NOTE: The use of a soap & water solution may aid in the removal of the hangers from the grommets.

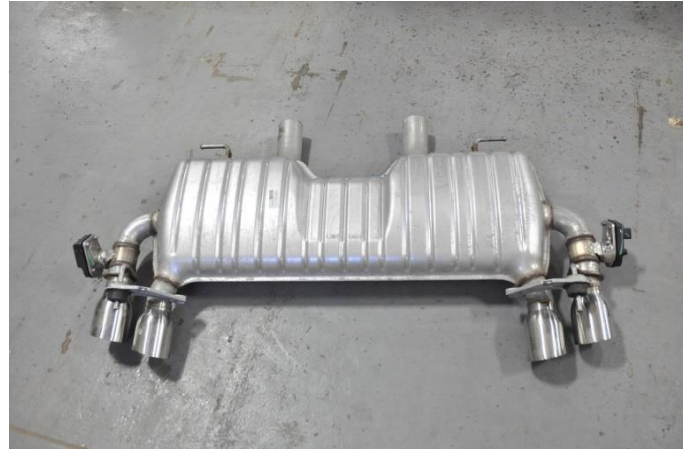

- 6.** Push up slightly on the exhaust, and then slide the stock rear muffler rearward to free the rear grommet assemblies from their mounting on the chassis. This will free the rear muffler from the vehicle.



- 7.** Note the orientation of each factory grommet assembly. Remove both the driver and passenger side hanger grommet assemblies from the rear mufflers using grommet pullers or a similar device.

NOTE: Save the factory grommet assemblies for the installation of the Corsa axle back exhaust system.



- 8.** Carefully and thoroughly de-burr both stock tunnel section outlet pipes from any burrs and sharp edges. This is important, as any burrs will prevent the rear muffler inlet pipes from sliding over the stock exhaust pipes.

Continued on Next Page ...

REMOVAL INSTRUCTIONS

FACTORY EXHAUST



9. Remove the three screws securing each valve control unit to the outer stock tips using an 8mm socket and 1/4" ratchet. Label each unit with the position it was installed to make sure it goes back to the same location.

NOTE: Save the valve control units and mounting hardware for installation of the CORSA axle back exhaust system.

Step 9 concludes the removal of the factory exhaust.

WARNING! DO NOT SKIP THIS STEP!

Apply the anti-seize lubricant (*supplied*) to the threads **ONLY** of all the clamps and flange bolts. Failure to follow this procedure can cause nuts to seize on clamps and potentially destroy threads.

After applying anti-seize lubricant, be sure to **thoroughly** clean your hands, as lubricant will tarnish stainless steel.

All clamps should be tightened using a properly calibrated Torque Wrench. Using an air impact gun will damage the clamp and reduce its ability to effectively seal the joint. It may also cause the joint to separate, thereby causing damage to your exhaust system and to your vehicle.

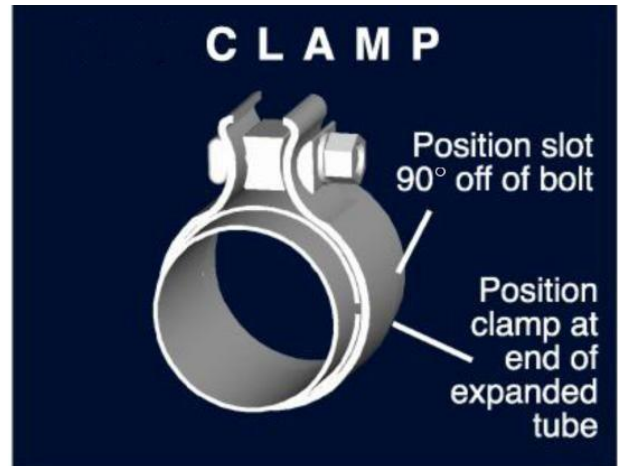

NOTE: Align all clamps so that the center of the clamp bolt is 90 degrees from the notch in the pipe.

INSTALLATION INSTRUCTIONS

CORSA EXHAUST



1. Locate the passenger muffler and the valve control unit removed from the passenger side of the stock muffler in removal step 9. Orient valve to match the rotation of the valve control unit as it was when removed from stock exhaust.



2. Locate the valve control unit mounting hardware from removal step 9 and start all three screws by hand.

Continued on Next Page ...

INSTALLATION INSTRUCTIONS

CORSA EXHAUST



- 3.** Tighten the three screws using an 8mm socket and 1/4" ratchet. Repeat steps 1-3 for driver side muffer.



- 4.** Locate one of the 2.75" clamps and slide over inlet of the passenger muffer. Orient the clamp so the bolt is vertical with the nut towards the ground and the bolt towards the inside of the vehicle.

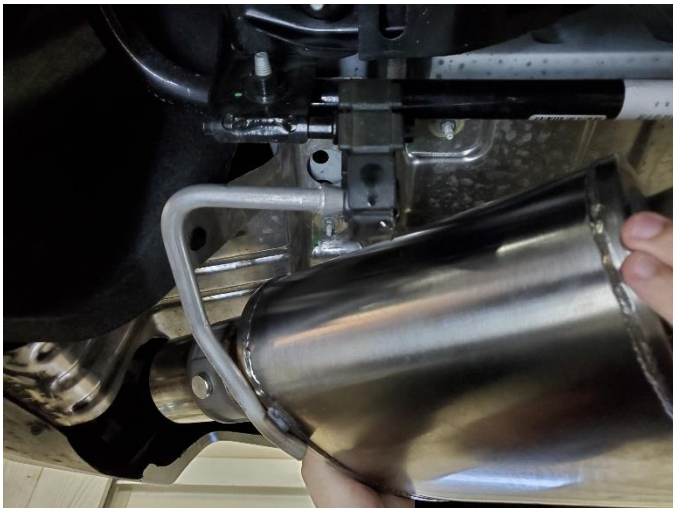

- 5.** Slide the muffer hanger into the hanger grommet located behind the rear suspension of the vehicle.



- 6.** Slide the inlet pipe over the outlet pipe of the stock exhaust.

Continued on Next Page . . .

INSTALLATION INSTRUCTIONS

CORSA EXHAUST



- 7.** Snugly tighten the clamp securing the muffler inlet pipe using a 15mm deep socket and 3/8" ratchet, leaving it loose enough for later adjustment.



- 8.** Locate one of the wire harness extensions.

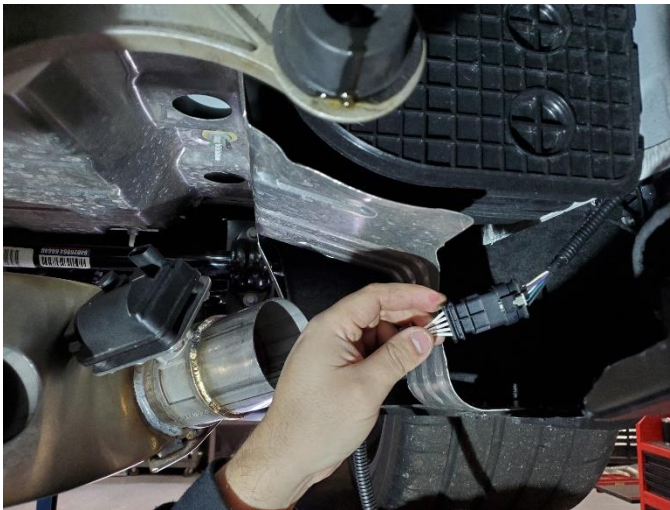

- 9.** Connect the extension to the stock wiring harness. Press down gray locking tab to secure.



- 10.** Route the wiring harness around the heat shield.

Continued on Next Page . . .

INSTALLATION INSTRUCTIONS

CORSA EXHAUST



- 11.** Connect the other end of the extension to the valve control unit. Press down gray locking tab to secure. Repeat steps 4-11 for the driver side muffler.



- 12.** Locate the passenger outer tip assembly and the stock hanger grommet assembly removed from the passenger side in removal step 7.



- 13.** Install the stock hanger grommet assembly onto the tip hanger.
NOTE: The use of a soap & water solution may aid in the installation of the hangers.



- 14.** Locate one of the 3" clamps and slide the clamp onto the inlet of the tip assembly. Orient the clamp so the bolt is vertical with the nut towards the ground and the bolt towards the inside of the vehicle.

Continued on Next Page . . .

INSTALLATION INSTRUCTIONS

CORSA EXHAUST

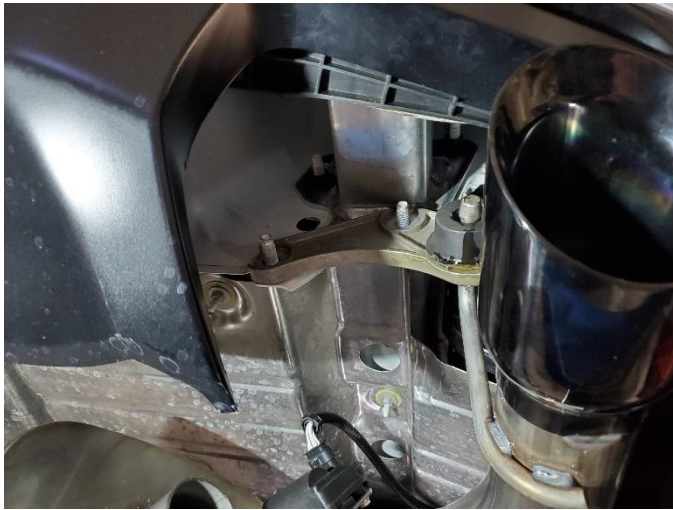

15. Install the stock hanger grommet assembly onto the mounting studs.

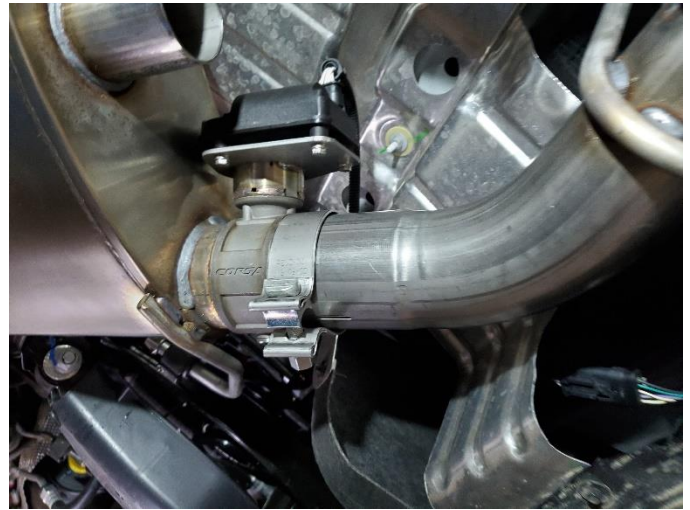

16. Slide the tip assembly inlet onto the valve outlet of the muffler.



17. Locate the stock hanger grommet assembly mounting hardware from removal step 4 and start them by hand onto the mounting studs.

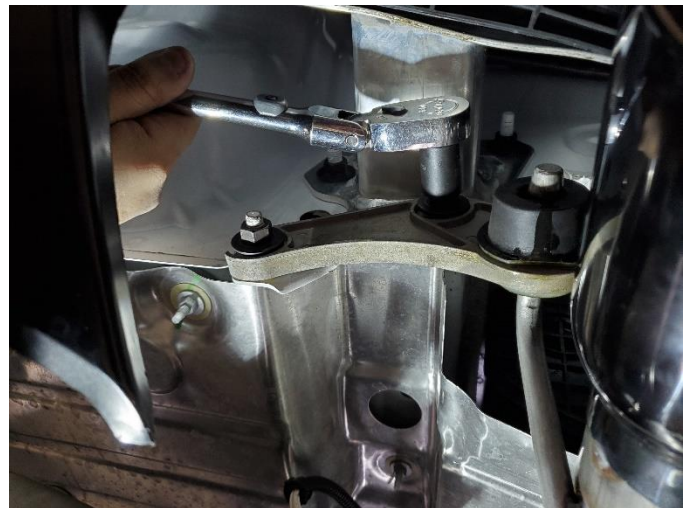

18. Tighten the hanger grommet assembly hardware using a 15mm socket and 3/8" ratchet. Repeat steps 12-18 for the driver side outer tip assembly.

Continued on Next Page ...

INSTALLATION INSTRUCTIONS

CORSA EXHAUST



19. Locate the passenger inner tip assembly and one 2.25" clamp and slide the clamp onto the inlet of the tip assembly. Orient the clamp so the bolt is vertical with the nut towards the ground and the bolt towards the inside of the vehicle.



20. Slide the tip assembly onto the smaller outlet of the muffler.



21. Snugly tighten the clamp securing the outer tip assembly to the muffler using a 15mm deep socket and 3/8" ratchet, leaving it loose enough for later adjustment.



22. Snugly tighten the clamp securing the inner tip assembly to the muffler using a 15mm deep socket and 3/8" ratchet, leaving it loose enough for later adjustment. Repeat steps 19-22 for the driver side inner tip assembly.

Continued on Next Page . . .

INSTALLATION INSTRUCTIONS

CORSA EXHAUST



- 23.** Adjust the system accordingly, including the rear muffler rotation and overlap onto the stock exhaust, along with the tip depth and rotation, so that the tips are centered in the bumper valence. Check the position of all hangers to make sure they are properly seated within their corresponding grommets. Check clearances between the system components and chassis. Tighten all clamps to 45ft-lbs using the torque wrench and 15mm socket.

This concludes the installation of your CORSA exhaust system.

NOTE: During cold weather start-ups, you may experience an exhaust sound that is deeper and louder in tone than usual. This is temporary and will diminish to normal levels once your engine has reached its normal operating temperature.

NOTE: Immediately following the installation of your exhaust system, you may experience a trace of smoke after initial start-up. DO NOT be alarmed. The smoke is caused by the burning of a small amount of forming oil residue used in the manufacturing process.

NOTE: It is strongly suggested that all clamps be checked and tightened after road testing the vehicle once the system has cooled.