



## IMPORTANT WARRANTY & INSTALLATION INSTRUCTIONS ATTACHED

*Please Forward All Attached Information to Consumer  
Warranty Not Valid Unless Returned to CORSA Exhaust*

We ask that you take a few moments to complete our warranty registration form:

TO ACTIVATE YOUR LIMITED LIFETIME WARRANTY GO TO:

**[CORSAPERFORMANCE.COM/WARRANTY](https://corsaperformance.com/warranty)**



MADE IN THE USA



For Full-Color Installation Instructions, Please Visit:

**[CORSAPERFORMANCE.COM](https://corsaperformance.com) and Search by Part Number**

Please be sure to review the enclosed instructions prior to beginning the installation process.  
If you have any questions about the enclosed parts, instructions or encounter a problem during  
Installation: **CALL CORSA PERFORMANCE TECHNICAL ASSISTANCE AT  
800.486.0999**

**Please take time to read and understand these installation instructions.**

CORSA recommends that installation of this system be performed by a qualified service center or professional muffler installer who has the necessary equipment, tools and experienced personnel. However, if you decide to perform this install, the use of a hoist and an additional person will be required.

**CAUTION:** Never work on a hot exhaust system. Allow time for the vehicle to cool. Always wear eye protection when working under a vehicle.

Please confirm that all parts are present before beginning the factory exhaust system removal and CORSA exhaust system installation.

## Recommended Tools:

Safety Glasses, 7mm socket, 15mm socket, Ratchet, Grommet pullers, Torque wrench, Small flathead screwdriver

## Bill of Materials:

### PN 14951 (V8 Manual Transmission)

- Front Pipe (16CF4051)
- Axle-Pipe Assembly - Passenger (16CF4057)
- Axle-Pipe Assembly- Driver (16CF4038)
- Rear Muffler Assembly - Passenger (16CF2038)
- Rear Muffler Assembly - Driver (16CF2036)
- XO-Pipe Assembly (16CF4037)
- Hardware Kit (15CV7000)
- Packet of Anti-Seize

### PN 14952 (V8 Automatic Transmission)

- Front Pipe (16CF4051)
- Axle-Pipe Assembly - Passenger (16CF4057)
- Axle-Pipe Assembly - Driver (16CF4038)
- Rear Muffler Assembly - Passenger (16CF2038)
- Rear Muffler Assembly - Driver (16CF2036)
- XO-Pipe Assembly (16CF4056)
- Hardware Kit (16CF7036)
- Packet of Anti-Seize

### PN 14953 (V6 Auto and Manual)

- Front Pipe (16CF4051)
- Axle-Pipe Assembly - Passenger (16CF4057)
- Axle-Pipe Assembly- Driver (16CF4038)
- Rear Muffler Assembly - Passenger (16CF2053)
- Rear Muffler Assembly - Driver (16CF2051)
- XO-Pipe Assembly (16CF4060)
- Hardware Kit (16CF7047)
- Packet of Anti-Seize

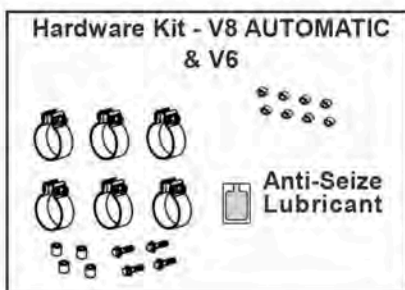

Rear Muffler Assembly  
DRIVER  
(16CF2036) - V8  
(16CF2051) - V6

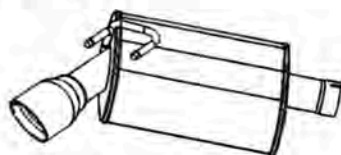

Rear Muffler Assembly  
PASSENGER  
(16CF2038) - V8  
(16CF2053) - V6

Axle-Pipe Assembly  
DRIVER  
(16CF4038)

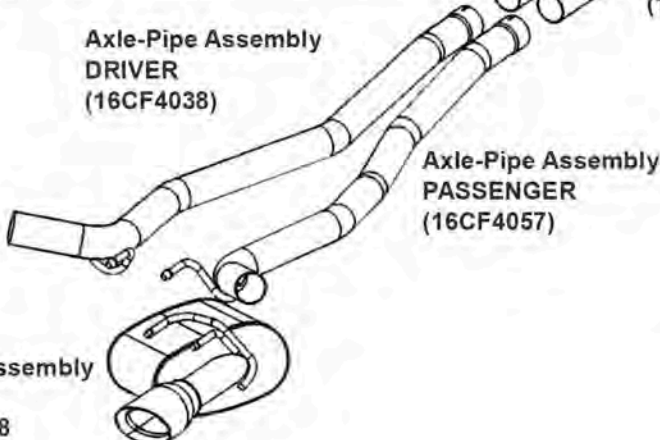

Axle-Pipe Assembly  
PASSENGER  
(16CF4057)

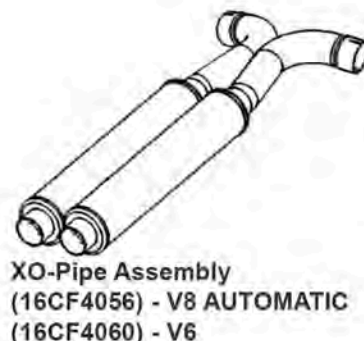
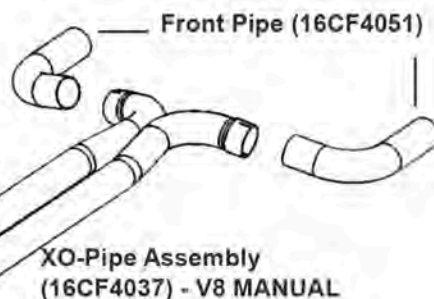

## 2014 SKIP STEPS 1 & 2. START INSTALLATION AT STEP 3

- Using a 7mm socket, remove and save the bolts from the rear fascia (2 at the outside corners, 4 in the middle). (See Fig. A, B)
  - Carefully separate the bottom section of the rear fascia by pulling out the tabs on the outside edges. (See Fig. C) There is one on each side.
  - For V6 & V8 Auto: Remove and save the 4 bolts securing the cross brace near the middle of the car using a 15mm socket, and set brace aside (See Fig. D). The brace and the bolts will be reinstalled after the CORSA system is in place.
  - For Convertible: Remove and save the 8 bolts holding the cross brace near the front of the car using a 15mm socket, and set the brace aside. The brace and bolts will be reinstalled after the CORSA system is in place. (See Fig. E)
  - For Convertible: Using a 15mm socket and ratchet, remove the 3 bolts and nut holding in the driver side sub-frame bracing. Repeat on the passenger side. (See Fig. F, G, H, I)
  - Loosen the sleeve clamps on the factory front pipes using a 15mm socket & pry away the retaining clips using a small flathead screwdriver. (See Fig. J, K)
  - While preventing the tips from hitting the rear fascia, remove the hangers above the rear mufflers. This may be easiest to remove the double grommet from the car and muffler all at once. (See Fig. L) Repeat on the opposite side.
- NOTE:** The use of a soapy water solution may aid in the removal and later installation of the hangers in the rubber isolators.
- Using a grommet puller or similar device, remove the axle pipe hangers. While supporting the mufflers and front pipes, remove the system from the front pipes by moving system towards the rear. Lower the front of the system first, allowing the clearance to then lower the mufflers. (See Fig. M, N & O) The removal of the factory system is complete.

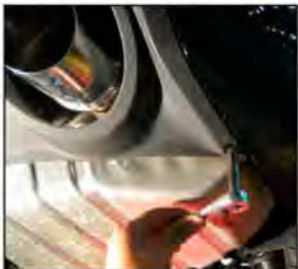

FIG. A



FIG. B

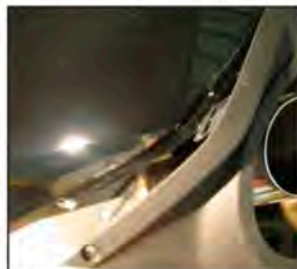

FIG. C

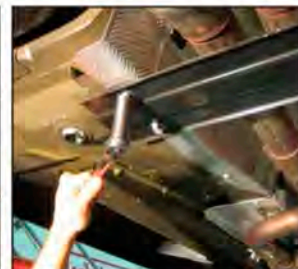

FIG. D

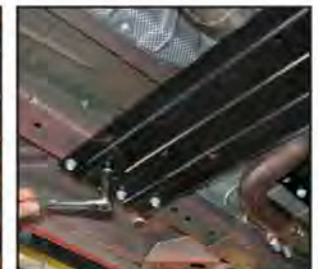

FIG. E



FIG. F



FIG. G



FIG. H



FIG. I



FIG. J



FIG. K

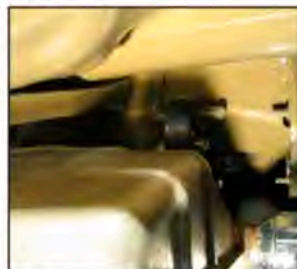

FIG. L



FIG. M



FIG. N

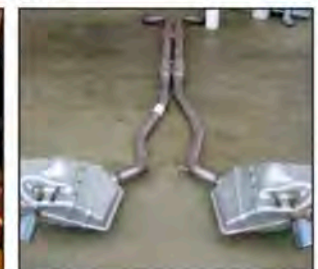

FIG. O

## Installation of CORSA Exhaust System:

**NOTE:** Apply the anti-seize lubricant (supplied) to the threads ONLY of all the clamps and flange bolts. Failure to follow this procedure can cause nuts to seize on clamps and potentially destroy threads. After applying anti-seize lubricant be sure to thoroughly clean hands as lubricant will tarnish stainless steel. All clamps should be tightened using a properly calibrated Torque Wrench. Using an air impact gun will damage the clamp and reduce its ability to effectively seal the joint. It may also cause the joint to separate thereby causing damage to your exhaust system and your vehicle.

### **2010-2013 MODELS ONLY: REASSEMBLE REAR FASCIA (REVERSE OF FACTORY EXHAUST REMOVAL STEPS 1 & 2)**

1. Install the front pipes of the CORSA system into the sleeve clamps on the factory pipes and loosely snug the sleeve clamps using a 15mm socket. **(See Fig. K, L)**
2. Install the cross brace **(See Fig. M)**. For V6 and V8 Auto cars, use the 4 longer spacers and the new bolts for the cross brace in the middle of the car. **(See Fig. N)** For Convertible, use the 8 shorter spacers and the factory bolts for the cross brace near the front of the car. The factory sub-frame braces can also be reinstalled at this time. Torque the bolts to 18 ft-lbs. This will temporarily support the xo-pipe in the next step while you continue the install.
3. Slide a clamp over the inlet expansion of the xo-pipe and slide the front pipe into the expansion **(See Fig. O, P)**. Do not torque anything yet, but clamp can be loosely tightened. Repeat installing the clamp and front pipe on the other side.
4. Slide clamps over the inlet ends of the axle pipes and slide the expanded end of the axle pipe over the xo-pipe **(See Fig. Q)**, then slide the hanger into the rubber grommet near the differential **(See Fig. R)**. Repeat on the other side.



FIG.K



FIG. L



FIG. M



FIG. N

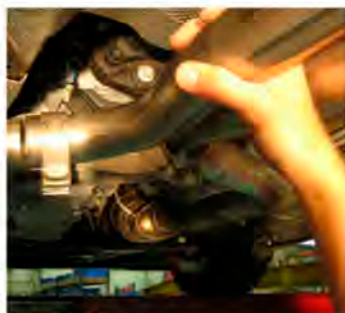

FIG.O



FIG. P



FIG. Q

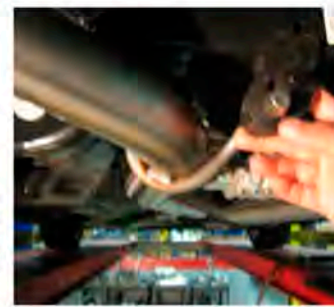

FIG. R

- Slide the double rubber grommets over the hangers on the CORSA rear mufflers. Being careful not to damage the rear fascia or the exhaust tips, slide the rubber grommet over the stock hangers on the vehicle. (See Fig. S)
- Slide a clamp over the expanded inlet of the rear muffler and slide the expanded inlet over the outlet of the axle pipe (See Fig. T). The clamp can be loosely tightened at this time. Be sure to check for clearance to the spare tire well. (See Fig. U) Repeat on the other side.
- Starting at the front of the vehicle, tightening all the connections while holding the xo-pipe at least 1" off the cross brace. If installing on a V8 auto or V6 car, the tunnel muffler should be held up against the heat shield while tightening all clamps. It will drop slightly when the support is removed. If working alone, a wood block or similar item can be used to hold this distance. Torque all clamps to **45ft-lbs** (See Fig. V, W).



FIG. S



FIG. T

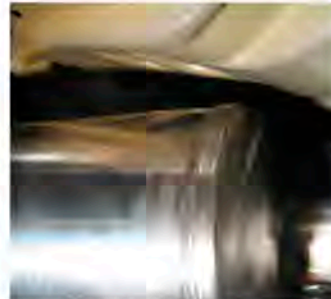

FIG. U



FIG. V

- Check clearance around the rear muffler and make adjustments at the clamp joints to properly align.
- It is **strongly suggested** that all clamps be checked and tightened if needed after road testing the vehicle once the system has cooled.

**NOTE:** During cold weather start-ups, you may experience an exhaust sound that is deeper and louder in tone than usual. This is temporary and will diminish to normal

levels once your engine has reached its normal operating temperature.

**NOTE:** Immediately following the installation of your CORSA exhaust system, you may experience a trace of smoke after initial start-up. DO NOT be alarmed. The smoke is caused by the burning of a small amount of forming oil residue used in the manufacturing process.



FIG. W