



INSTALLATION GUIDE: AWE EXHAUST SUITE FOR THE SUBARU BRZ/TOYOTA GR86/TOYOTA 86

For up-to-date fitment information, please visit the product page on [AWE-Tuning.com](https://www.awe-tuning.com).

THIS GUIDE IS INTENDED FOR THE FOLLOWING PART NUMBERS:

- 3020-32279 AWE Track Edition Exhaust for Subaru BRZ / Toyota GR86 / Toyota 86 -- Chrome Silver Tips
- 3020-33279 AWE Track Edition Exhaust for Subaru BRZ / Toyota GR86 / Toyota 86 -- Diamond Black Tips
- 3015-32486 AWE Touring Edition Exhaust for Subaru BRZ / Toyota GR86 / Toyota 86 -- Chrome Silver Tips
- 3015-33486 AWE Touring Edition Exhaust for Subaru BRZ / Toyota GR86 / Toyota 86 -- Diamond Black Tips

Welcome to the AWE family, and congratulations on your purchase of the AWE Exhaust System for the Subaru BRZ/ Toyota GR86/Toyota 86.

Exquisite build quality and craftsmanship, coupled with industry leading performance, distinguish this exhaust system from all others.

*For up to the minute fitment information, be sure to visit the AWE website. As always, AWE Performance Specialists are standing by for any questions, [right here](#).

PARTS LIST (TOURING SYSTEMS)



Inspect **ALL** parts prior to disassembly of vehicle; If damaged or **MISSING**, please contact the place of purchase immediately.

Symbol	Part Number	Description	QTY
	E49	Subaru BRZ /Toyota GR86 Resonated Inlet	1
	E50	Subaru BRZ /Toyota GR86 Axle Tube	1
	E51	Subaru BRZ /Toyota GR86 Twin HR1 Section	1
	E53	Subaru BRZ /Toyota GR86 Tip Outlet	2
A >>	180250	2.5" Band Clamp	2
B >>	180300	3" Band Clamp	2
C >>	3910-11012	Lock Collar Clamp Kit	1
D >>	3910-41010	**Only takes 1 of these kits per set of 2 or 4 tips** YELLOW Hardware Kit for Integrated Clamp Style Exhaust Tips - Quad	1
E >>	180006	5.00" OD x 3.00" ID, Slash Cut, Chrome Silver, AWE logo, Integrated Clamp	2
E >>	180007	5.00" OD x 3.00" ID, Slash Cut, Diamond Black, AWE logo, Integrated Clamp	2

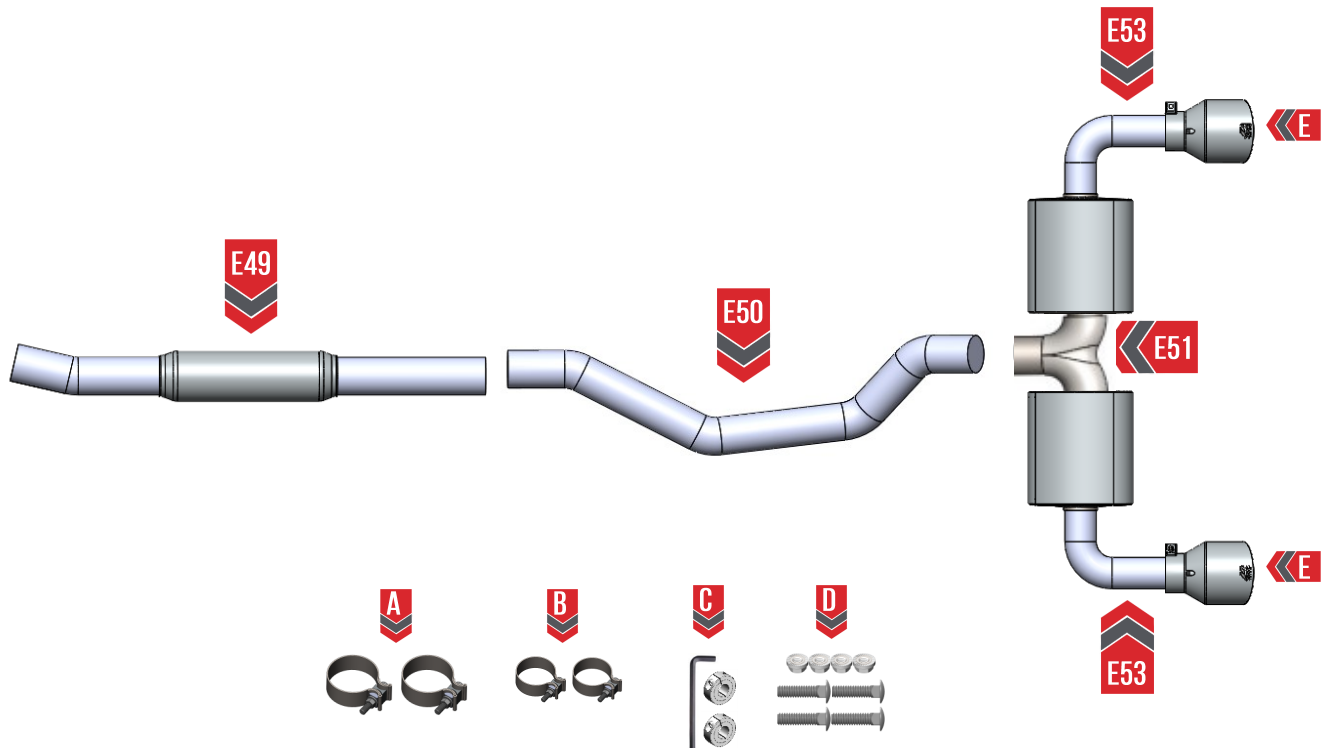

PARTS LIST (TRACK SYSTEMS)



Inspect **ALL** parts prior to disassembly of vehicle; If damaged or **MISSING**, please contact the place of purchase immediately.

Symbol	Part Number	Description	QTY
	E49	Subaru BRZ /Toyota GR86 Resonated Inlet	1
	E50	Subaru BRZ /Toyota GR86 Axle Tube	1
	E52	Subaru BRZ /Toyota GR86 Track Rear	1
	E53	Subaru BRZ /Toyota GR86 Tip Outlet	2
A >>	180250	2.5" Band Clamp	2
B >>	180300	3" Band Clamp	2
C >>	3910-11012	Lock Collar Clamp Kit	1
D >>	3910-41010	**Only takes 1 of these kits per set of 2 or 4 tips** YELLOW Hardware Kit for Integrated Clamp Style Exhaust Tips - Quad	1
E >>	180006	5.00" OD x 3.00" ID, Slash Cut, Chrome Silver, AWE logo, Integrated Clamp	2
E >>	180007	5.00" OD x 3.00" ID, Slash Cut, Diamond Black, AWE logo, Integrated Clamp	2

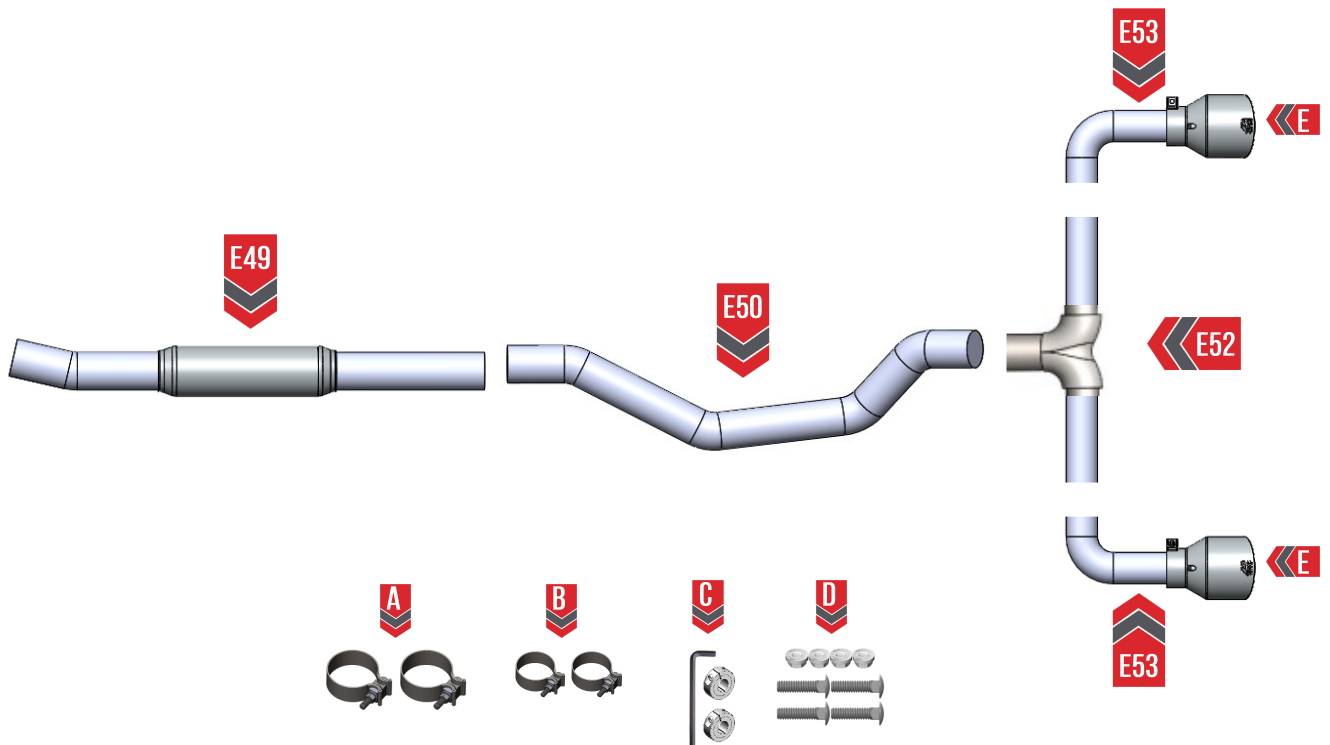



NOTE: Always refer to the manufacturer's service manual for precise torque specifications on all OEM fasteners.



CAUTION: The exhaust may be **VERY HOT** — allow adequate time for the system to cool down before disassembly. Severe burns and injury will occur if skin comes into contact with a hot exhaust system.

STEP 1



Soak all bolts, and rubber hangers in penetrating oil before starting any work.

1. To begin remove the OE hardware located at **(A)**, this hardware will be reused.
2. Remove the OE hanger bar from the rubber hanger as shown at **(B)**.
3. Remove the OE hardware located at **(C)**, this will allow you to remove the OE midpipe.
4. Lastly remove the hanger bars from the four OE rubber hangers shown at **(D)**, to remove the OE muffler from the cavity.

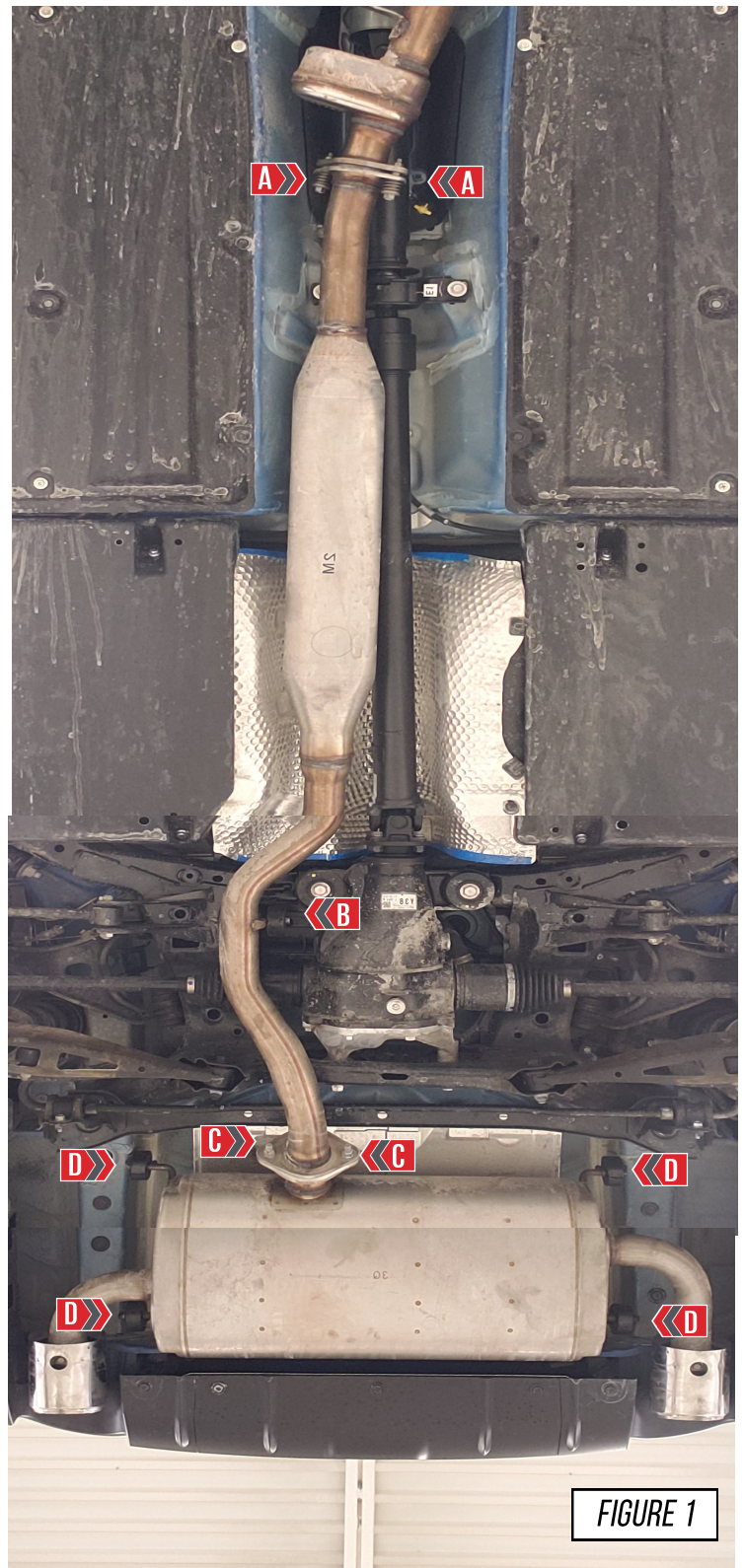

FIGURE 1

STEP 2

Install the AWE resonated inlet section (**E49**), as shown in **Figure 2-1**. Using your OE exhaust donut and the OE hardware, fully tighten the AWE resonated inlet section to the OE front pipe shown at (**A**) in **Figure 2-1**.

Note: When you tighten down the hardware support the rear, and make sure to center the pipe on the donut, so the hardware tightens evenly.

You want to ensure the shoulders on the bolts are fully making contact with the flange as shown at (**B**) in **Figure 2-2**.

Note: If a replacement exhaust donut gasket is needed please contact Subaru with part number 44022AA123.

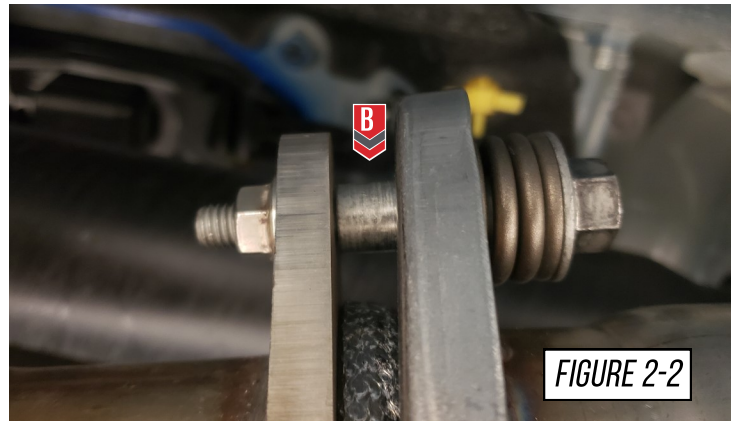
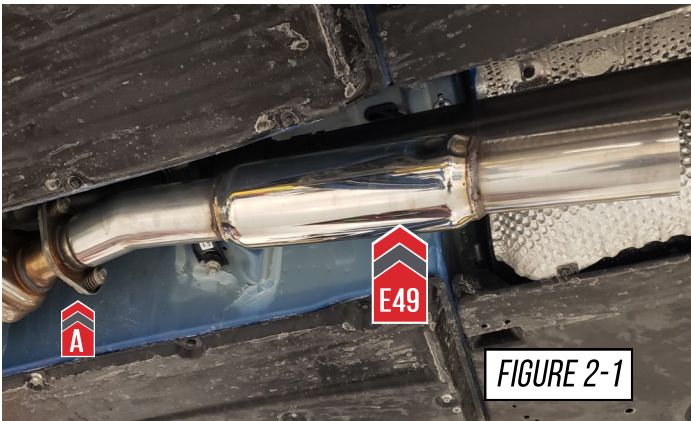

STEP 3

It is crucial to install each section and exhaust band clamps correctly to prevent loose joints, exhaust leaks and rattles.

Arrow A shows the expanded pipe and the preinstalled exhaust clamp being brought up to the corresponding pipe.

Arrow B shows the overlapping pipe installed correctly over the corresponding pipe.

Arrow C shows the exhaust band clamp being brought to the edge of the expanded pipe.



NOTES:

- **Do not** fully torque any exhaust clamp until the entire exhaust has been installed and adjusted.
- Torque specification is a **minimum** of 60 ft/lbs

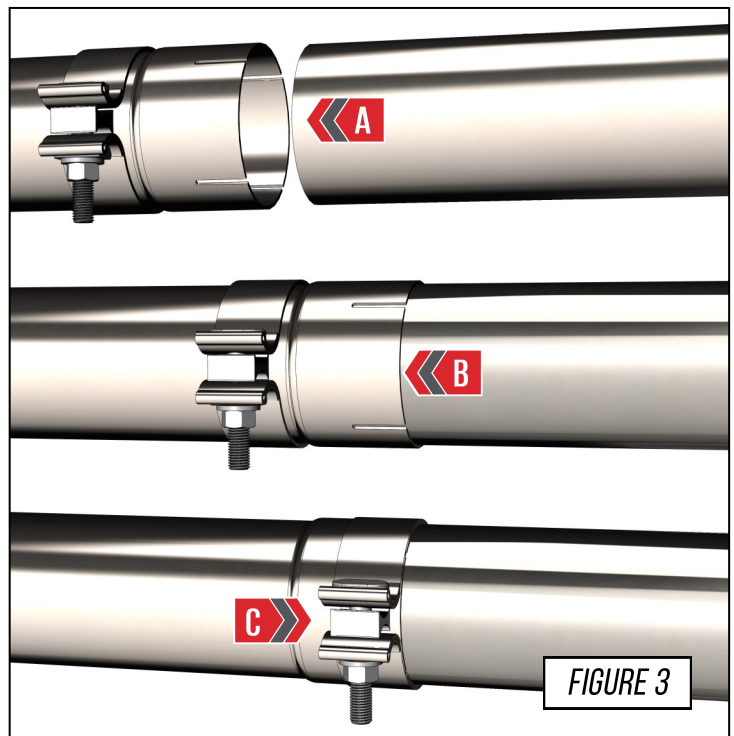

STEP 4

Slide a provided 3 inch clamp over your AWE axle tube (**E50**) and bottom out the slip joint on your AWE resonated inlet section (**E49**) shown at (**A**) in **Figure 4-1**.

Next slide the hanger bar into the OE hanger shown at (**B**) in **Figure 4-2**. It is important to make sure the hanger bar is parallel to the ground.

Note: Snug the clamp but do not fully tighten it at this point.

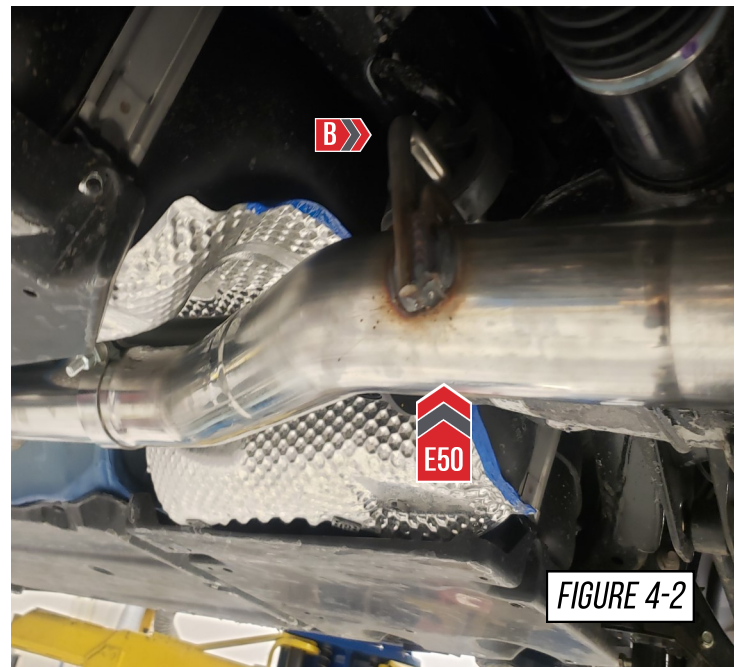
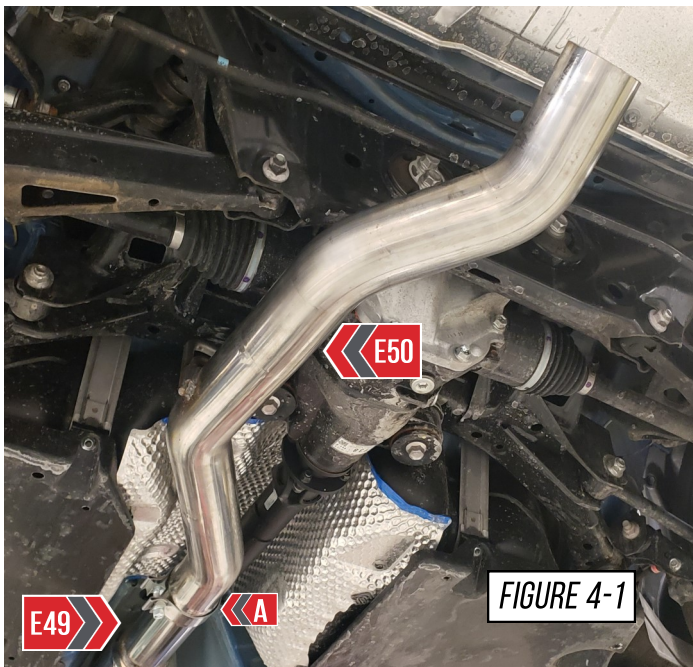

STEP 5



STEPS 5 AND 6 ARE FOR TRACK SYSTEMS ONLY



Slide a provided 3 inch clamp over your AWE axle tube (**E50**), then install your AWE track rear section (**E52**) as shown in **Figure 5**.

Slide the hanger bars into the rear OE hangers as shown at (**A**).

Next snug the clamp over the slip joint as shown at (**B**) but do not fully tighten it at this time.

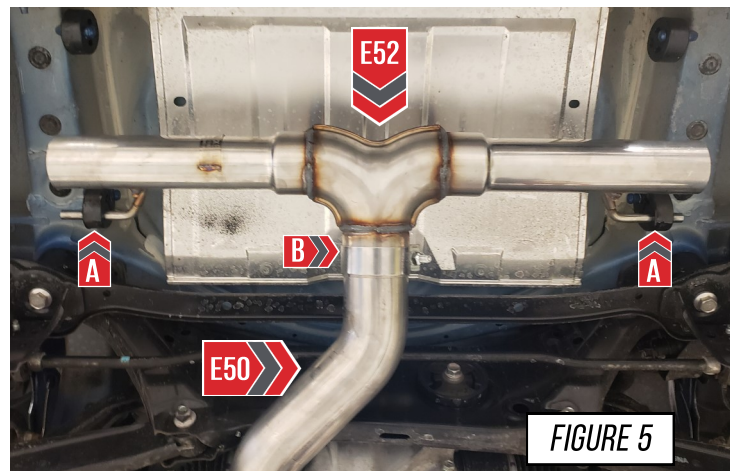

STEP 6

Install your AWE tip outlet sections (**E53**), do this by sliding a provided 2.5 inch clamp on each side of your AWE track rear section (**E52**). Snug the clamp but do not fully tighten to allow for adjustment.



STEP 7



STEPS 7 AND 8 ARE FOR TOURING SYSTEMS ONLY



Slide a provided 3 inch clamp over your AWE axle tube (**E50**), then install your AWE twin HR1 section (**E51**) as shown in **Figure 7-1**. Slide the hanger bars into the OE hangers as shown at **(A)** in **Figure 7-2**, and at **(B)** in **Figure 7-3**. At this point snug the clamp over the slip joint but do not fully tighten it

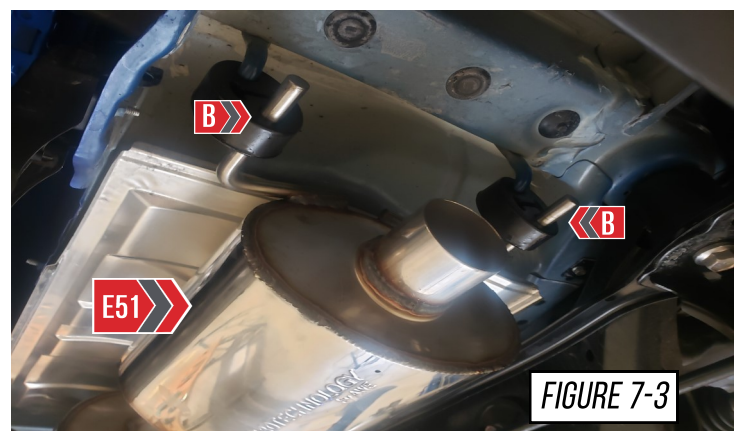
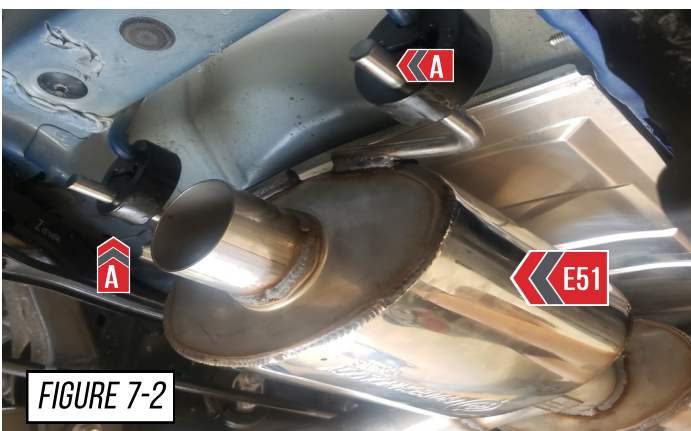
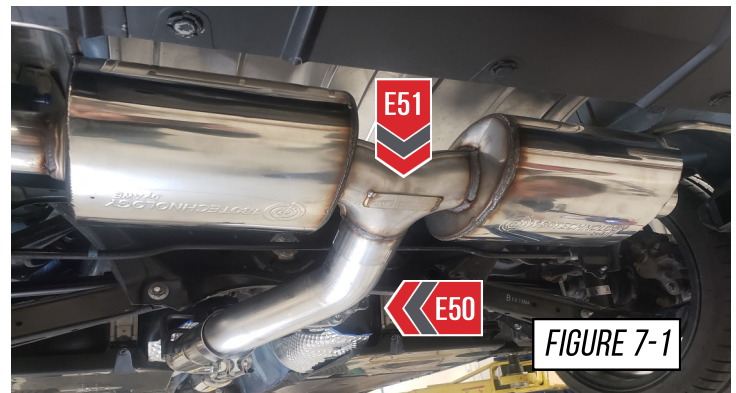

STEP 8

Install your AWE tip outlet sections (**E53**), do this by sliding a provided 2.5 inch clamp on each side of your AWE twin HR1 section (**E51**). Then bottom out the outlet section onto the twin HR1 section, as shown in **Figure 8-1**, and **Figure 8-2**. Center the outlet sections in the tip cutout, then snug the clamps.



It is very important to fully bottom out both tip outlets on the twin HR1 section, to ensure proper function.

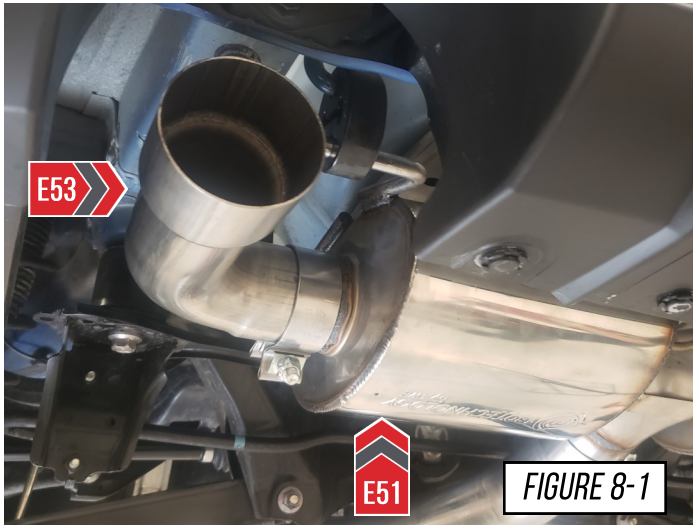

FIGURE 8-1

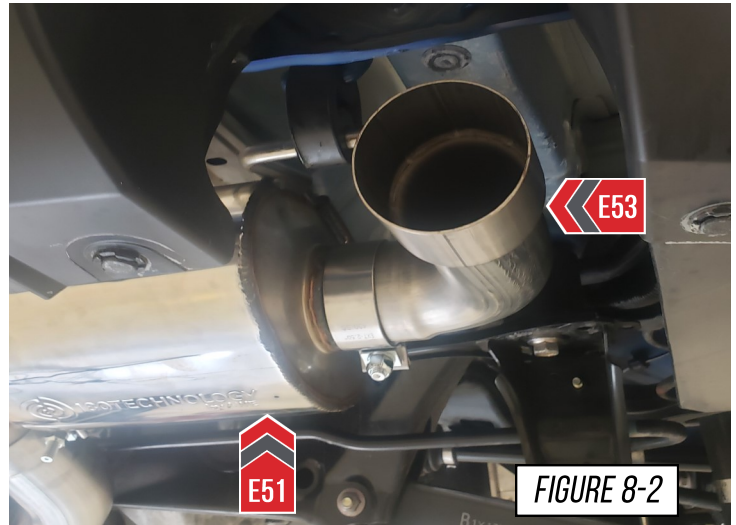

FIGURE 8-2

STEP 9

To install the exhaust tips with integrated clamps, first, attach the exhaust tip in the proper orientation onto the exhaust outlet tube.

Insert one of the carriage bolts from the hardware kit (**3910-41010**) through the tab on the exhaust tip and thread on one of the corresponding nuts.

Using anti-seize on the bolt threads will help installation and prevent breakage of hardware.



If exhaust system only has 2 exhaust tips while the integrated clamp kit has enough hardware for our 4 tip exhaust systems. You will have 2 sets of hardware left over that will not be used.

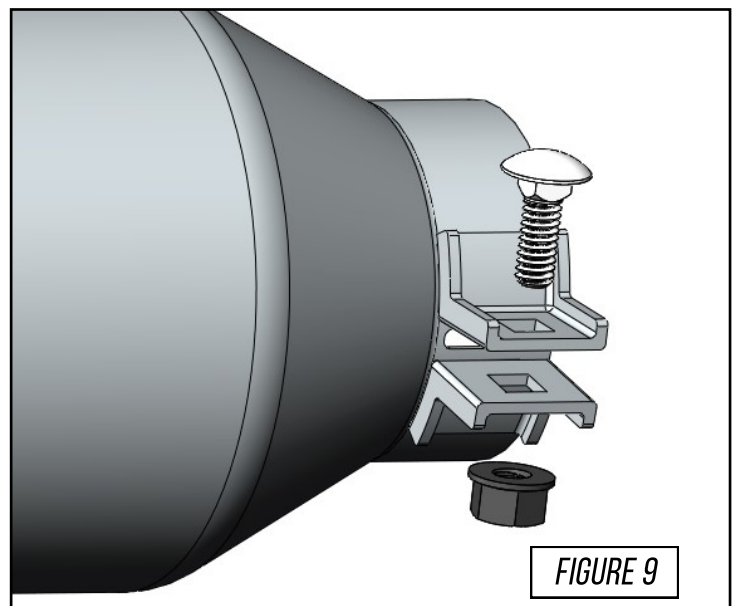

FIGURE 9

STEP 10

Using the provided hardware install your AWE exhaust tips. Slide the tip over the outlet clamp, and tighten the clamp.

Ensure that your tips are centered in the tip cutout, as shown in **Figure 10**.

After your tips are secured on the outlet tubes if they are not centered push the entire rear section until the desired location is achieved.



STEP 11



STEP 11 IS FOR TRACK SYSTEMS ONLY



With the desired tip location achieved install the provided lock collars in place as shown at (A) in **Figure 11-1**, and at (B) **Figure 11-2**.

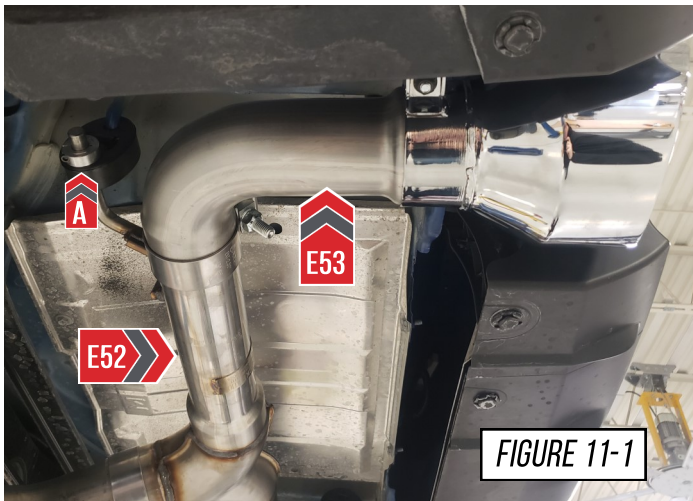

STEP 12



STEP 12 IS FOR TOURING SYSTEMS ONLY



With the desired tip location achieved install the provided lock collars on the rear most hangers as shown at (A) in **Figure 12-1**, and at (B) **Figure 12-2**.

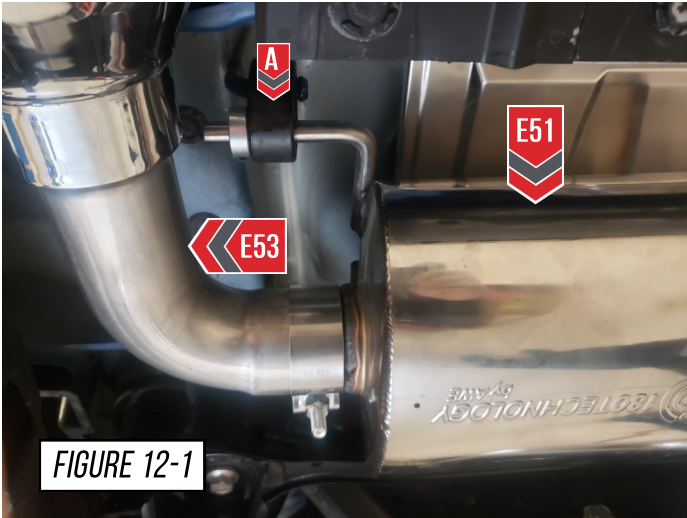

FIGURE 12-1

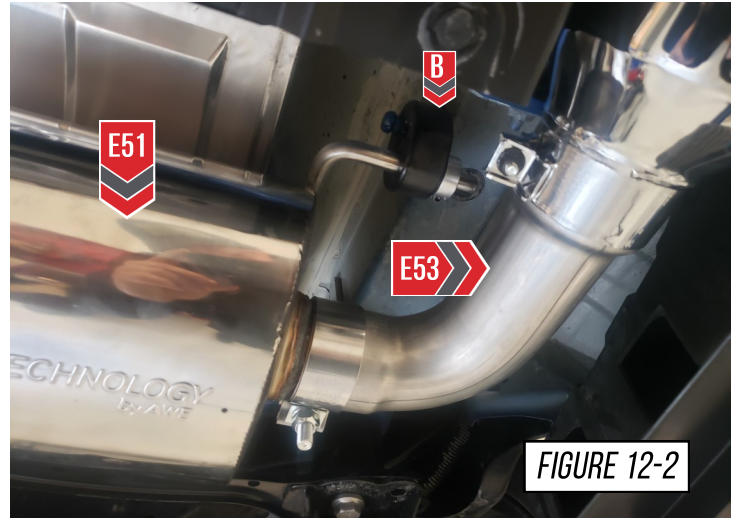

FIGURE 12-2

STEP 13

Make your final adjustments to the tips to ensure they are in a position you like. Once the desired positioning is achieved, fully tighten down all clamps.

It is now recommended to drive the car to allow the exhaust to heat cycle after all clamps and tips are fully tightened.



At this point the exhaust will be **very hot**, allow to cool before work continues.

Check the tips for correct alignment, adjust as needed.



Don't forget to see the next page for any troubleshooting needs!



ENJOY!



TROUBLESHOOTING

Issue	Solution
Exhaust is not fitting correctly	Most fitment issues are due to improperly adjusted exhaust. This includes tip fitments and rattling due to chassis contact. Check out our fitment guide for more installation tips.
Incorrect or missing parts	Double check the parts list for your system and compare them with what you received. Fill out our contact form, found below and let us know what parts you need.

CARE

Once installed properly, your AWE exhaust will provide years of trouble-free performance.

The exhaust volume and sound will settle with usage; 800-1000 miles is required to break-in new exhaust systems.

Also, please note that the rear **180Technology**® resonator has a small drain hole to allow condensation to escape. Water drops from this area are normal.

Periodic cleaning of exhaust tips is necessary to maintain proper finish, especially in areas prone to road salt and caustic deicing solutions. Use a mild soap and water solution or car wax to clean the finish. Avoid using abrasive polishes, as they can scratch the finish.

Any questions or comments,
please do not hesitate to contact us:

AWE
215-658-1670
[CONTACT FORM](#)

WARRANTY

Up-to-date warranty information is found [HERE](#).