

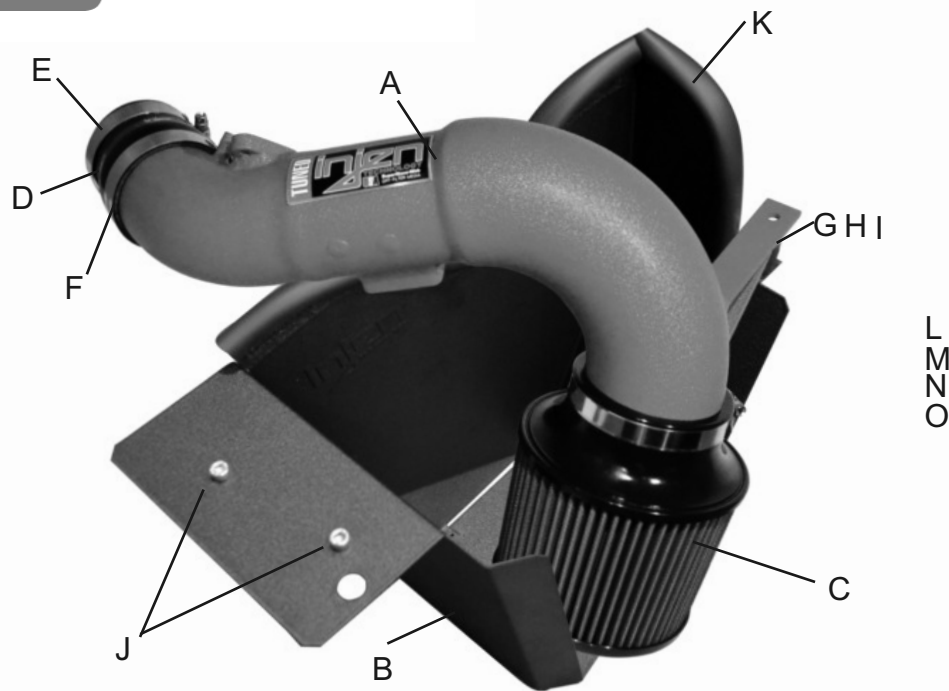

**Vehicle Application:**  
**Make: Honda**  
**Model: Type R (FK8)**  
**Year: 2017-18**  
**Engine: 2.0L 4-cyl. Turbo**



Item	QTY.	P/N	Description
A	1	Y-SP1582	Intake Tube
B	1	#11156	Heat shield
C	1	#1015	3.5" Dry Air Filter
D	1	#3120	2.75x3" Step hose
E	1	#4003	#40 clamp
F	1	#4004	#48 clamp
G	1	#6020	M6 vibramounts
H	1	#6010	Fender washers
I	1	#6002	M6 nuts
J	2	#6083	Socket cap m6 screw
K	1	#6058	Rubber trim @ 20" Length
L	1	#3087	6mm hose @ 16.5"Length
M	1	#3220	10mm hose @7" Length
N	1	#8008	1/4" plastic coupler
O	1	#8013	3/8" plastic coupler

- TOOLS REQUIRED**
- 10mm Ratchet & Socket
  - 8mm nut drive
  - Allen key
  - Flat Blade Screwdriver
  - Phillips Screwdriver

**WARNING:** FAILURE TO FOLLOW INSTALLATION INSTRUCTIONS AND NOT USING THE PROVIDED HARDWARE MAY DAMAGE THE INTAKE SYSTEM, ENGINE AND COMPONENTS!!!  
**\*Do not attempt to install the intake system while the engine is hot.**  
 Severe burn could result from touching hot engine components!

Report any defective or missing parts to the authorized Injen dealer you purchased this product from. Before installing any parts of this system, please read the instructions thoroughly. If you have any questions regarding installation, please contact your Injen Technology dealer. Installation DOES require some mechanical skills. A qualified mechanic is always recommended.

A Limited Lifetime Warranty to the original purchaser against defects in material and workmanship on all Injen intake systems excluding the filter element. Any and all warranty coverage is limited to the repair or replacement of the defective part only, at Injen Technology's discretion. The warranty does not cover incidental or consequential damages, nor does it cover the cost of installation or removal of the defective part or its replacement. Proof of purchase is required.

# Instruction Manual P/N:SP1583

**NOTE:** This intake kit may not work on vehicles with the following aftermarket modifications.

- Aftermarket Intercooler piping
- Aftermarket intercooler
- Turbo upgrade
- Modified body panels
- Suspension & Chassis modifications

Injen intake systems are street legal in most states unless the state is adopting to California Emissions standards. States that have adopted California emission standards include: Arizona, California, Connecticut, District of Columbia, Maine, Maryland, Massachusetts, New Jersey, New Mexico, New York, Oregon, Pennsylvania, Rhode Island, Vermont, and Washington. These states will require an California Air Resource Board Executive Order Number (CARB E.O.) for the legal use of an Injen intake system in your vehicle for use on public roads or highways. These vehicle will be considered "Legal in California only for racing vehicles competition use only, which may never be used upon a public street or highway. **Please keep your factory air box assembly for any future use.**



The SuperNano-Web filter media is a dry synthetic media that outperforms the competition. The media itself is a proprietary base blend of synthetics and cellulose. Cellulose fibers are larger than synthetic fibers, and have larger spaces between the fibers, causing contaminants to load in the depth of the media and plug the airflow path. This creates higher restriction levels and less capacity. The synthetic fibers in the SuperNano-Web media are submicron in diameter and have small interior fiber spaces, which result in more contaminants being captured on the surface of the media. This can help keep restriction levels low as the filter loads with dirt and containments



If you look at the picture to the left, you can see the Nano-fiber web on top of our base media. That web, or SuperNano-Web as we like to call it, helps trap smaller particles and protect your engine.

## **To Clean your filter:**

Carefully remove the filter from the housing. Once removed, wipe down the housing using a clean shop towel, being careful not to knock any dirt and/or debris in the air inlet. Your filters can be cleaned by carefully vacuuming the filter media from the dirty side, or by holding the filter with one hand and carefully blowing the filter media at a 45-degree angle from the clean side using low-pressure shop air (15-20 lbs. psi).

***\*IT IS IMPORTANT TO NOT USE ANY CLEANERS ON THE SUPERNANO-WEB MEDIA OR APPLY ANY OIL!!!***

**NOTE: DISCONNECT BATTERY BEFORE INSTALLATION!!! MAKE SURE VEHICLE IS COOL BEFORE INSTALLATION, COOLANT LINE WILL BE REMOVED.**

# Instruction Manual P/N:SP1583



1. Stock intake system shown.



2. Loosen the 2 bolts holding in the OEM rubber Ram scoop.

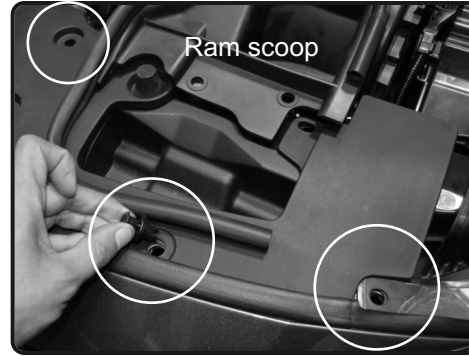

3. Carefully remove the push-clips from the upper engine cover.

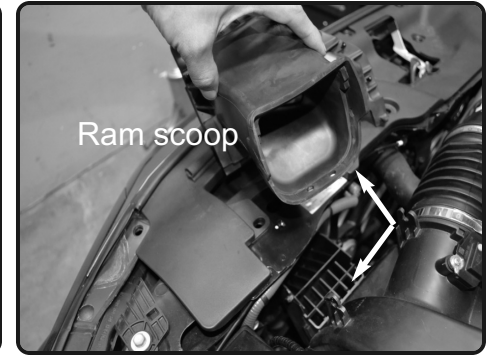

4. Now lift up and pull back the Rubber ram scoop. Note: there are plastic fittings holding in scoop, pull rubber away from fittings.

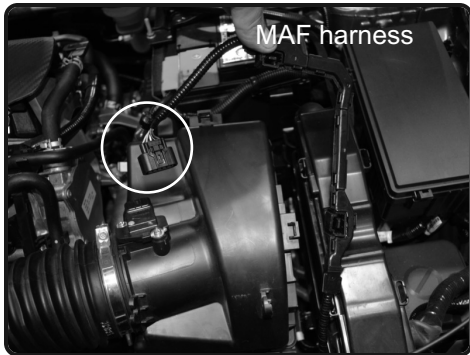

5. Disconnect the MAF sensor harness. Pull back the line away from the airbox.

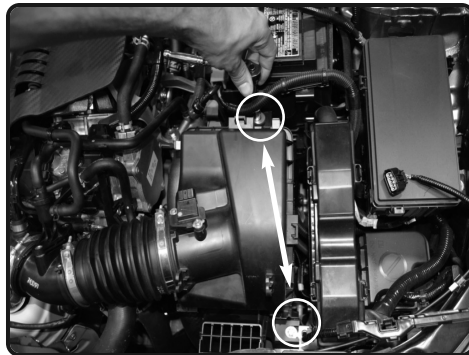

6. Loosen the two 10mm bolts holding in the stock air box.

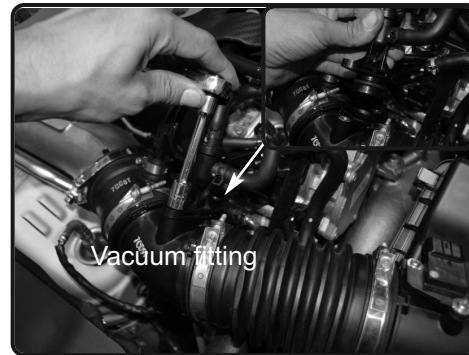

7. With 10mm socket, remove the 2 screws holding in vacuum fitting. Carefully pull back fitting.



8. Loosen the clamp on turbo using phillips screwdriver.

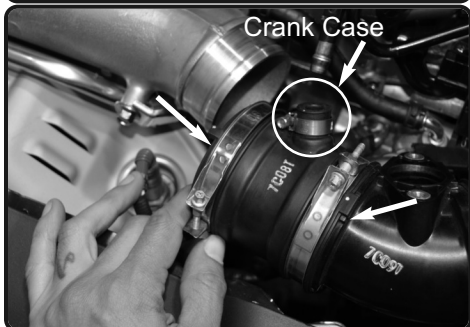

9. Now pull back the intake tube from turbo. Brake the crank case clamp using pliers to remove. Remove the crank case hardline out of intake tube.

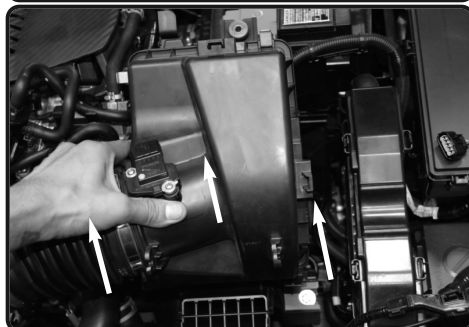

10. Lift up and remove the airbox.

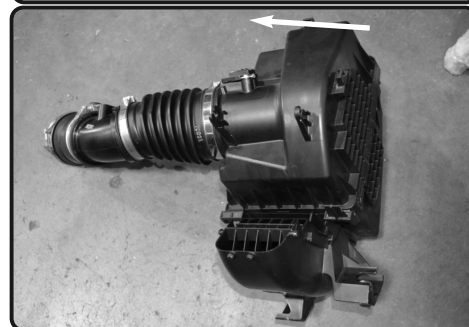

11. Complete stock air box removed.

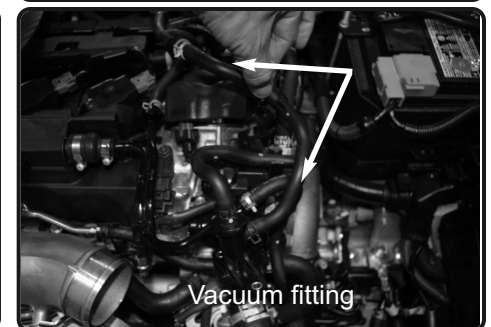

12. Now pull back vacuum line assembly out of way for the removal of the crankcase/coolant hardline.

# Instruction Manual P/N:SP1583

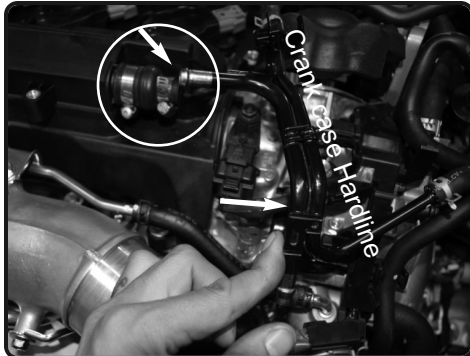

**13.** Brake the crank case clamp using pliers to remove. Pull the Crank case hard line out of the engine rubber coupler.

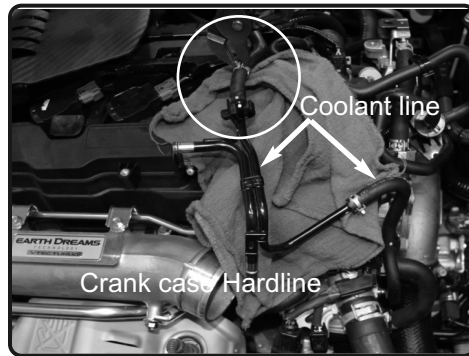

**14.** Use a shop towel or rag, with pliers, loosen the clamp on the top of the coolant line. Pull Clamp backwards to be re-used.

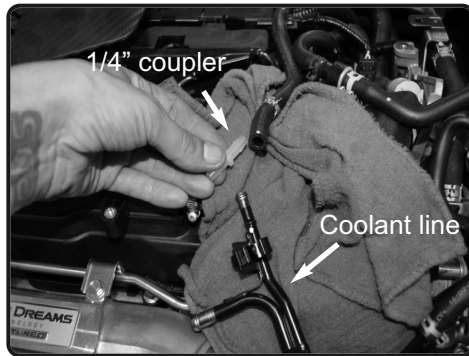

**15.** Pull back coolant line, now install provided 1/4" plastic coupler.

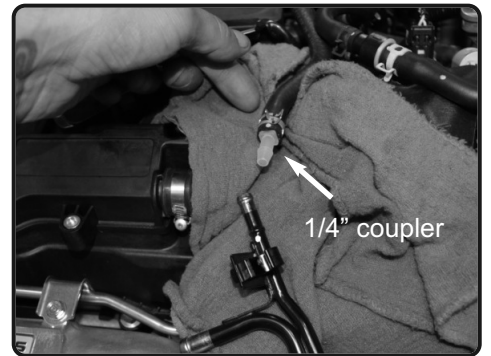

**16.** Install and secure the coupler using the OEM clamp from step 14.

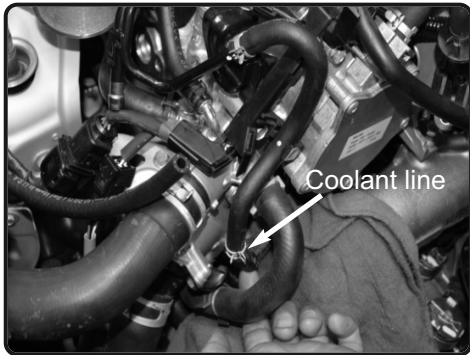

**17.** At other end of coolant line, Use a shop towel or rag, with pliers, loosen the clamp on the bottom of the coolant line. Pull Clamp backwards to be re-used.



**18.** Remove the complete Crankcase/coolant hardline from fitting out of vehicle



**19.** Remove clamp from the coolant line.



**20.** Install the clamp to the provided 6mm hose. Install and secure to the fitting from step 17.



**21.** Remove another clamp from the OEM Hardline assembly, and install to the other end of the 6mm hose.



**22.** Route the 6mm hose if desired.



**23.** Connect the coolant line to the coupler from steps 15 & 16.



**24.** Verify and make sure the new coolant line is secured.





**25.** Remove the plastic push clips and remove the plastic radiator shroud.

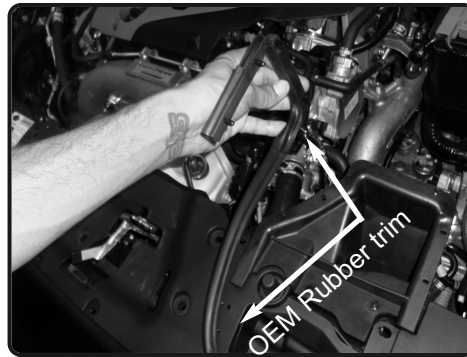

**26.** Remove the OEM rubber trim from the scoop using pliers. carefully pull out the clips holding in the rubber trim.



**27.** Complete OEM rubber trim removed. Remove the scoop.

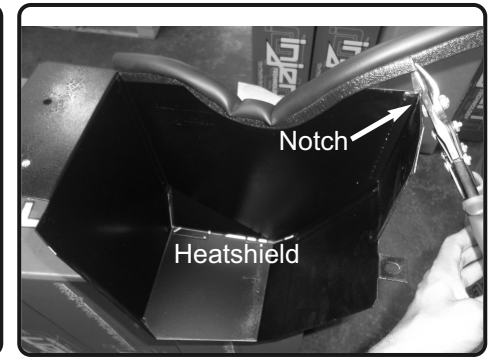

**28.** Install the rubber trim to the top of the heatshield, notch corner for easier installation.

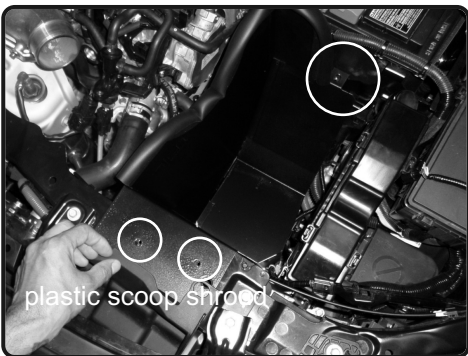

**29.** Install the heatshield and position. Make sure the heatshield sits on top radiator support. **MAKES SURE plastic scoop shroud sits on top of heatshield.**

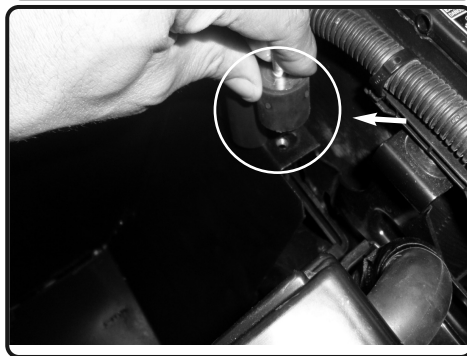

**30.** Now secure the back of the heat shield using M6 vibrmount.

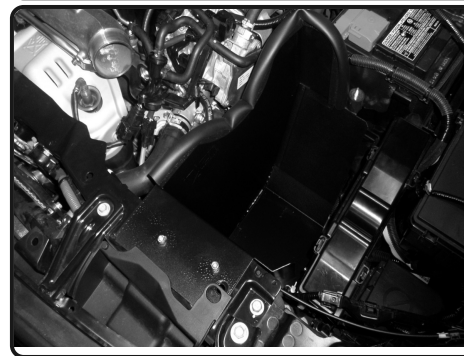

**31.** Secure the front of the heatshield using provided M6 socket cap screws.

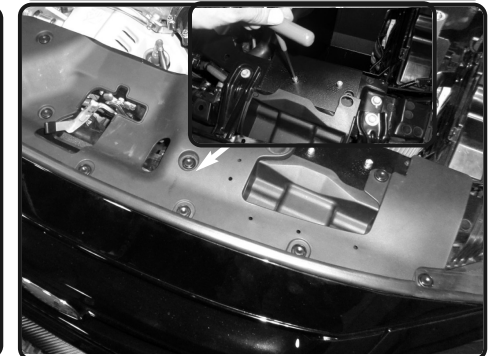

**32.** Secure and tighten screws using allen key. Re-install plastic radiator shroud.

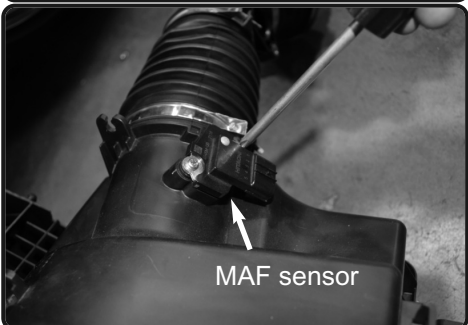

**33.** Loosen and remove the MAF sensor from the air box.

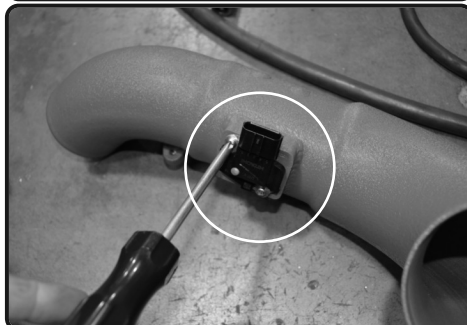

**34.** Install the MAF sensor into the new intake tube and secure using OEM screws. **Note: Make sure the sensor is going in the correct Direction!**



**35.** Install the provided step hose with clamps to the turbo.



**36.** Install the provided M6 vibramount to the OEM airbox mounting bracket. Secure and tighten.

# Instruction Manual P/N:SP1583

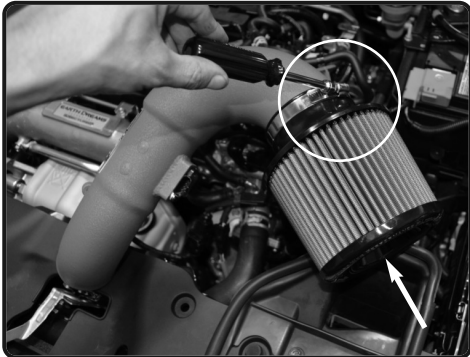

**37.** Install the air filter to the intake tube. Secure and tighten using 8mm nut driver.



**38.** Install the intake assembly into the vehicle. Position the bracket to the vibramount and tube to the step hose.

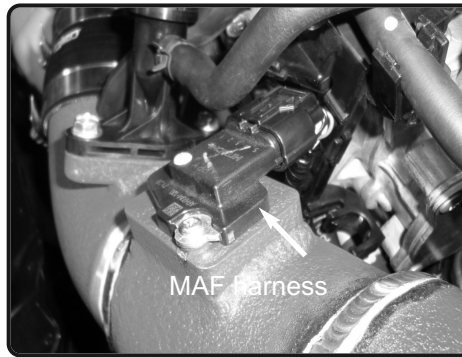

**39.** Connect the MAF sensor harness.

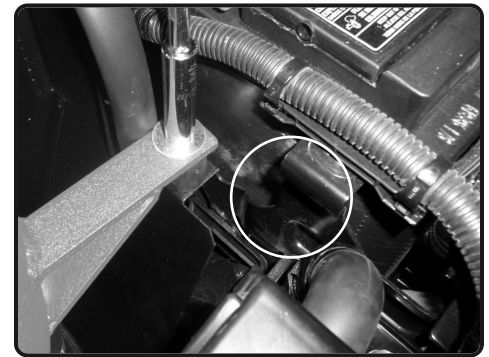

**40.** Secure the bracket using provided M6 nut and fender washer.

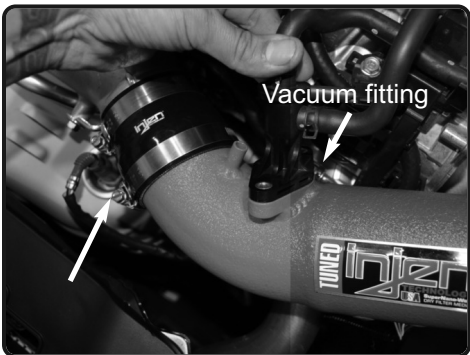

**41.** Attach the vacuum fitting to the flange adaptor. Adjust intake tube and tighten the clamps using 8mm nut driver.

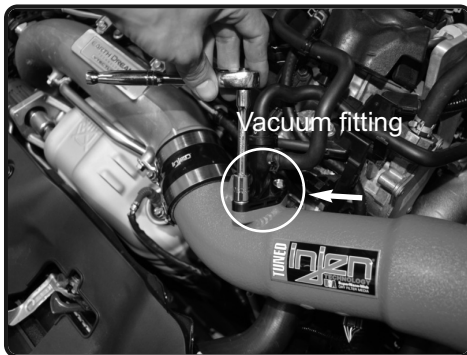

**42.** Secure the vacuum fitting using original screws from step 7.

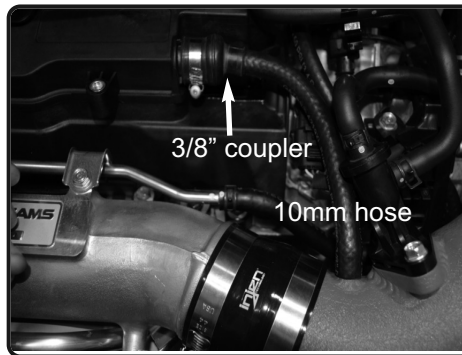

**43.** From step 13, connect the engine rubber coupler to the provided 10mm hose using provided 3/8" plastic coupler. Attach the 8mm hose to the fitting on intake tube. If hose is long, cut hose to correct 7" length. ***Make sure hose is not kinked or bend. May cause rough idle if hose is blocked or installed incorrectly.***

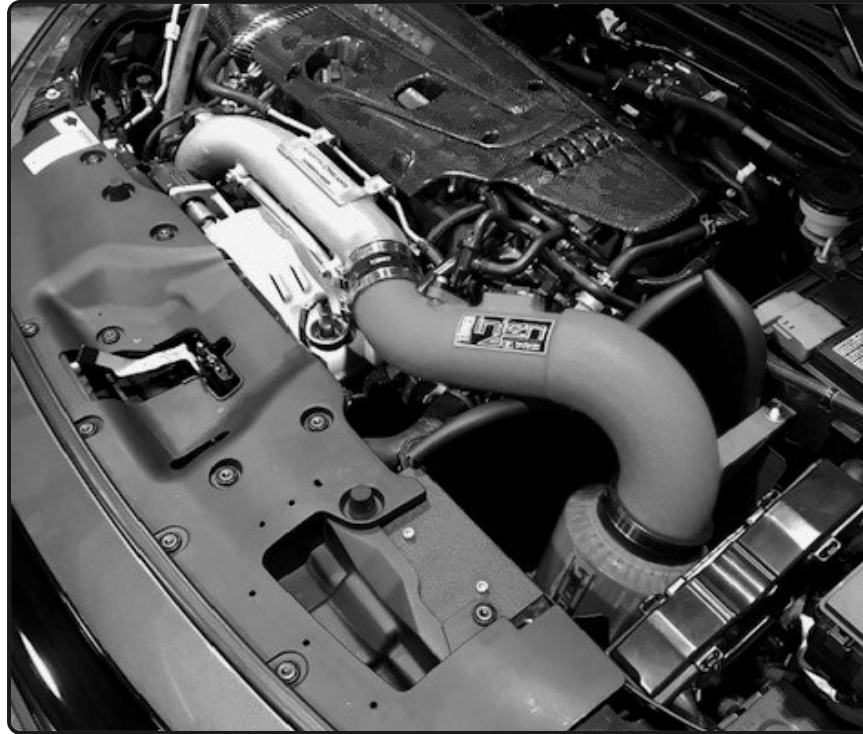

Congratulations! You have just completed the installation of this intake system. Periodically, check the alignment of the intake, normal wear and tear can cause nuts and bolts to come loose. **Note: Check clearance and adjust if needed! Failure to check the alignment and adjust the intake can cause damage that will void the warranty. Injen Technology is not responsible for any damages caused by/from improper installation.**

## Test Drive:

1. With the transmission in neutral or park and the parking brake engaged, start the engine. Listen for air leaks or odd noises. If air leaks are detected, secure hoses and connections. For any odd noises, inspect entire system for cause and adjust intake as needed. The Injen intake will function identically to the factory system but will be louder and more powerful.
2. Perform a road test. Listen for odd noises or rattles and fix as necessary.
3. If there are no issues, continue to enjoy your added performance from the Injen performance Intake kit.
4. Injen Technology recommends you periodically check clearance and adjust if needed! Failure to check the alignment and adjust the intake can cause damage that will void the warranty. Injen Technology is not responsible for any damages caused by/from improper installation.

1. Upon completion of the installation, reconnect the negative battery terminal before you start the engine.
2. Align the entire intake system for the best possible fit. Once the intake has been properly fitted continue to tighten all nuts, bolts and clamps.
3. Periodically, recheck the alignment of the intake system and make sure there is proper clearance around and along the length of the intake. Failure to follow proper maintenance procedures may cause damage to the intake and will void the warranty.
4. Start the engine and listen carefully for any odd noises, rattles and/or air leaks prior to taking it for a test drive. If any problems arise go back and check the vacuum lines, hoses and clamps that maybe causing leaks or rattles and correct the problem.
5. Check the filter for excessive dirt build up. Clean or replace the filter with an original Injen filter (can be bought on-line at "injenonline.com"). Congratulations! You have just completed the installation of the best intake system sold on the market. Enjoy the added power and performance of your new intake system.