

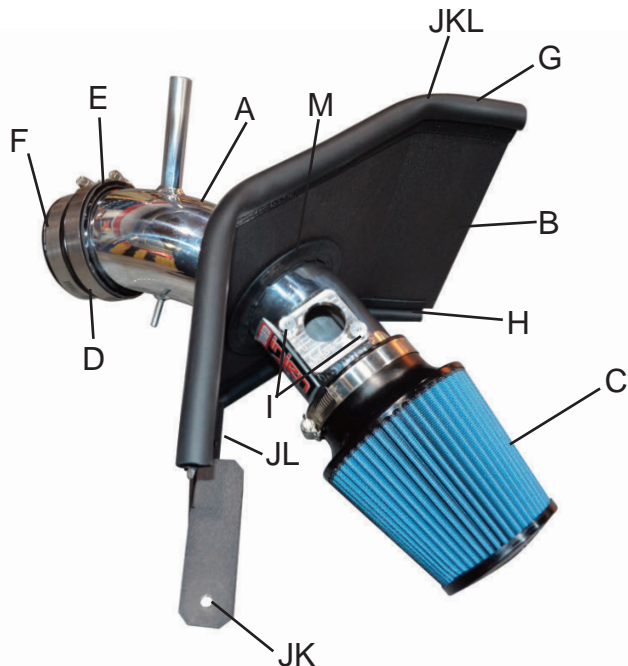

**Vehicle Application:**  
**Make: Toyota**  
**Model: Camry**  
**(Not CARB approved)**  
**Year: 2018-23**  
**Engine: 2.5L 4cyl.**



Item	QTY.	P/N	Discription
A	1	W-SP2037	Intake Tube
B	1	#11159	Heat shield
C	1	#1063BB	3.25" Dry filter (Blue Media)
D	1	#3141	Urethane step hose
E	1	#4005	#56 clamps
F	1	#4004	#48 clamps
G	1	#6023	Rubber trim @ 16.5"L
H	1	#6058	Rubber trim @ 9.5" L
I	2	#6047	M4 screws
J	3	#6005	M6 x 16 hex screw
K	2	#6011	Fender washer
L	2	#6002	M6 nuts
M	1	#6094	Bulb edge trim @ 13.5"L

- TOOLS REQUIRED**
- 10mm Ratchet & Socket
  - 8mm nut drive
  - Allen key
  - Flat Blade Screwdriver
  - Philllips Screwdriver

**WARNING:** FAILURE TO FOLLOW INSTALLATION INSTRUCTIONS AND NOT USING THE PROVIDED HARDWARE MAY DAMAGE THE INTAKE SYSTEM, ENGINE AND COMPONENTS!!!  
\*Do not attempt to install the intake system while the engine is hot.  
 Severe burn could result from touching hot engine components!

Report any defective or missing parts to the authorized Injen dealer you purchased this product from. Before installing any parts of this system, please read the instructions thoroughly. If you have any questions regarding installation, please contact your Injen Technology dealer. Installation DOES require some mechanical skills. A qualified mechanic is always recommended.

A Limited Lifetime Warranty to the original purchaser against defects in material and workmanship on all Injen intake systems excluding the filter element. Any and all warranty coverage is limited to the repair or replacement of the defective part only, at Injen Technology's discretion. The warranty does not cover incidental or consequential damages, nor does it cover the cost of installation or removal of the defective part or its replacement. Proof of purchase is required.

# Instruction Manual P/N:SP2037

**NOTE:** This intake kit may not work on vehicles with the following aftermarket modifications.

- Aftermarket Intercooler piping
- Aftermarket intercooler
- Turbo upgrade
- Modified body panels
- Suspension & Chassis modifications

Injen intake systems are street legal in most states unless the state is adopting to California Emissions standards. States that have adopted California emission standards include: Arizona, California, Connecticut, District of Columbia, Maine, Maryland, Massachusetts, New Jersey, New Mexico, New York, Oregon, Pennsylvania, Rhode Island, Vermont, and Washington. These states will require an California Air Resource Board Executive Order Number (CARB E.O.) for the legal use of an Injen intake system in your vehicle for use on public roads or highways. These vehicle will be considered "Legal in California only for racing vehicles competition use only, which may never be used upon a public street or highway. **Please keep your factory air box assembly for any future use.**



The SuperNano-Web filter media is a dry synthetic media that outperforms the competition. The media itself is a proprietary base blend of synthetics and cellulose. Cellulose fibers are larger than synthetic fibers, and have larger spaces between the fibers, causing contaminants to load in the depth of the media and plug the airflow path. This creates higher restriction levels and less capacity. The synthetic fibers in the SuperNano-Web media are submicron in diameter and have small interior fiber spaces, which result in more contaminants being captured on the surface of the media. This can help keep restriction levels low as the filter loads with dirt and containments



**A New Generation of Filters  
Designed to perform and  
filter like no other**

**INJEN SuperNano-Web Technology**

If you look at the picture to the left, you can see the Nano-fiber web on top of our base media. That web, or SuperNano-Web as we like to call it, helps trap smaller particles and protect your engine.

### **To Clean your filter:**

Carefully remove the filter from the housing. Once removed, wipe down the housing using a clean shop towel, being careful not to knock any dirt and/or debris in the air inlet. Your filters can be cleaned by carefully vacuuming the filter media from the dirty side, or by holding the filter with one hand and carefully blowing the filter media at a 45-degree angle from the clean side using low-pressure shop air (15-20 lbs. psi).

***\*IT IS IMPORTANT TO NOT USE ANY CLEANERS ON THE SUPERNANO-WEB MEDIA OR APPLY ANY OIL!!!***

**NOTE: DISCONNECT BATTERY BEFORE INSTALLATION!!!**



# Instruction Manual P/N:SP2037

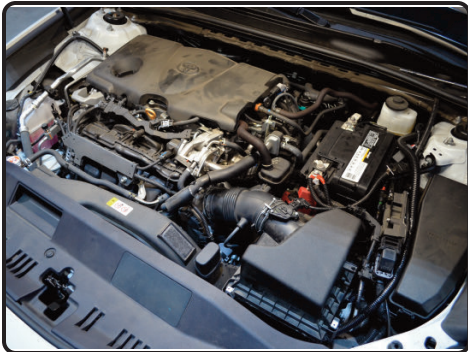

1. Stock intake system shown.

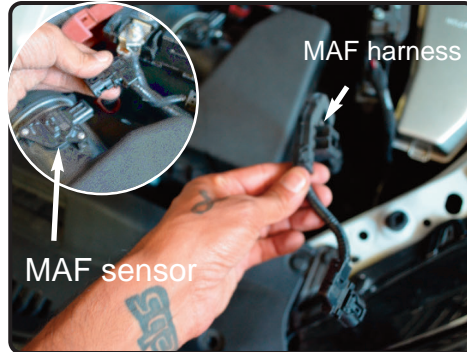

2. Disconnect the MAF sensor harness and pull harness cable from the air box.



3. Push the factory clamp in and pull back the crank case line away from the intake tube.

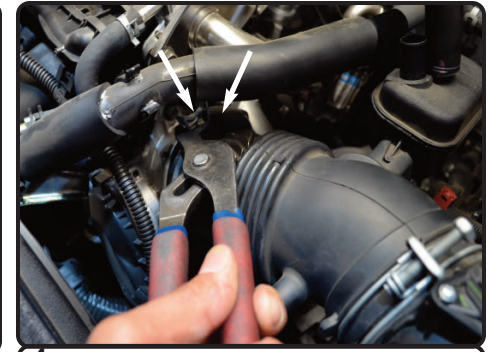

4. With pliers or channel locks carefully de-press the large clamp on the throttle body. Pull back the intake tube from the throttle body.



5. Pull back the vacuum line away from the intake tube.



6. Un-clip the upper half of the air box and remove the stock intake assembly out of the vehicle.

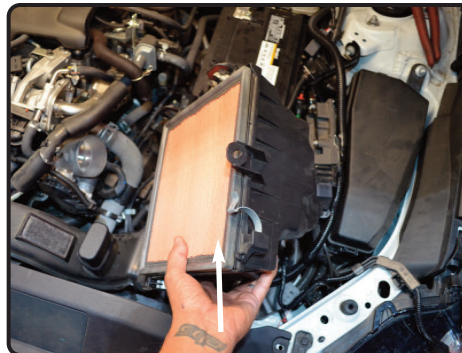

7. Lift up and remove the lower part of air box out of vehicle. Leave the front OEM ram scoop in vehicle.

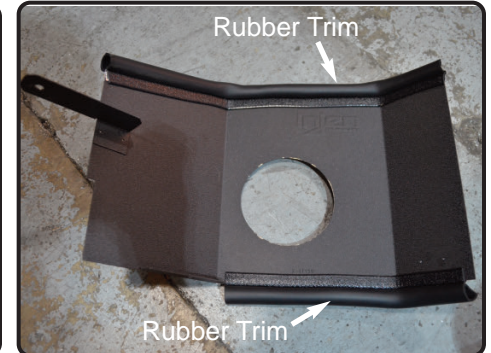

8. Add the Rubber trim to the top and bottom of the heatshield.

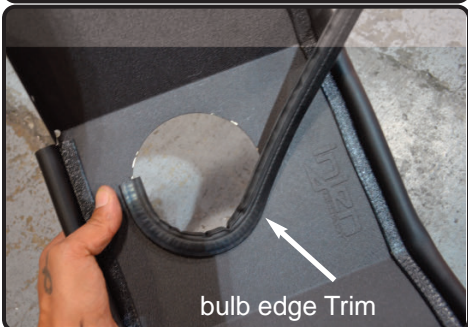

9. Partially install the bulb edge trim to the hole inside the heatshield.

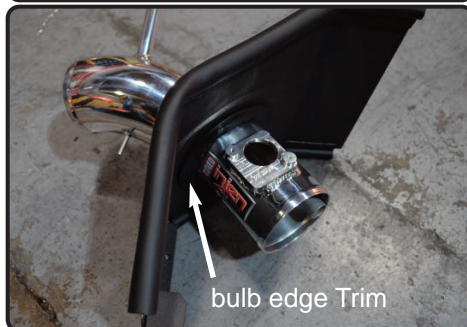

10. Install the intake tube through the hole with MAF sensor pad side. Maneuver and finish the rest of the bulb edge trim installation.

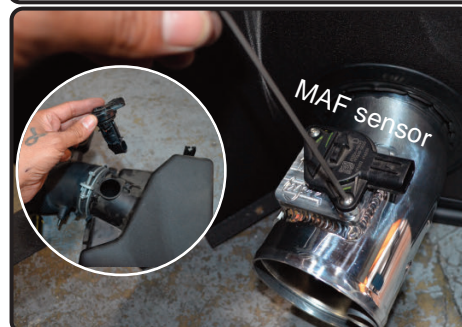

11. Remove the MAF sensor using phillips screwdriver. Install into the new intake tube and secure using provided M4 button head screws.



12. Push down on the clips on the radiator cover, remove clips and guard for installation of heatshield.



# Instruction Manual P/N:SP2037

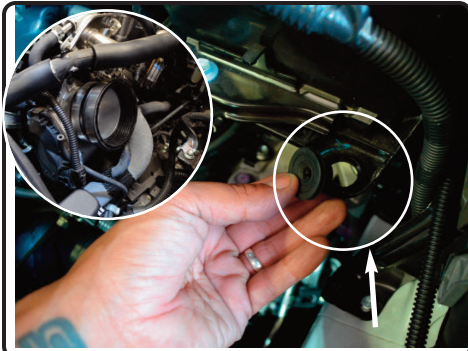

**13.** Remove the 1 grommet from the oem air box mounting brackets. Install the urethane step hose with clamps provided to the throttle body.



**14.** Now install the heatshield and position the brackets on heatshield to other mounting points.

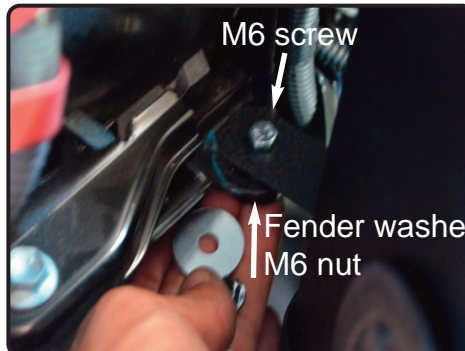

**15.** Secure the back of heatshield using M6 screw and M6 nut and washer. *Make sure Fender washer is secure on the nut side.*

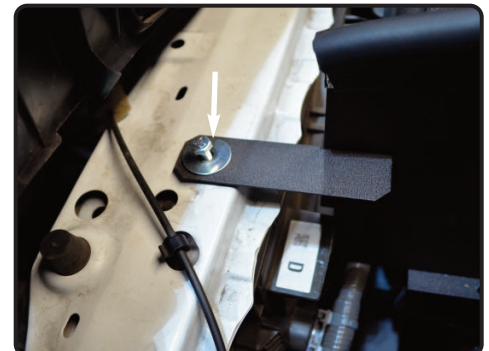

**16.** Place tab over the threaded insert. Secure using provided M6 hex screw and fender washer.

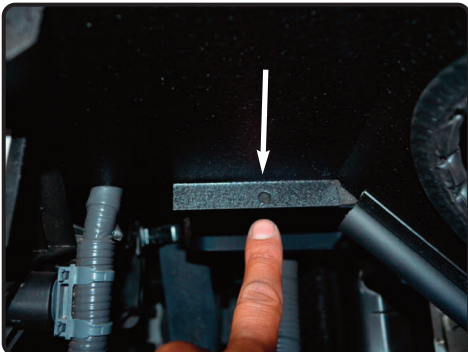

**17.** Locate the hole on the heatshield smaller tab. now that the OEM Ram scoop is under it, mark hole with marker.

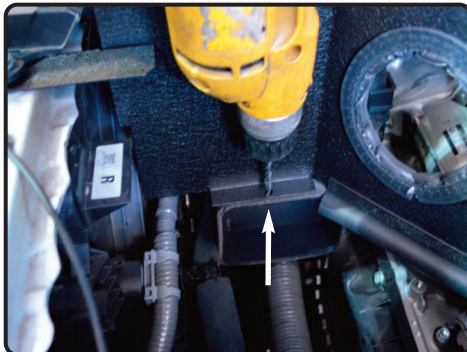

**18.** Drill hole to 1/4" on the OEM ram scoop.

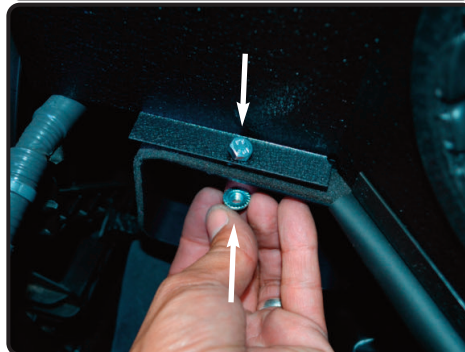

**19.** Secure using provided M6 screw and nut.



**20.** Now secure and tighten all the screws and nuts using socket or wrench.



**21.** Re-connect the OEM vacuum line to the fitting on the intake tube.

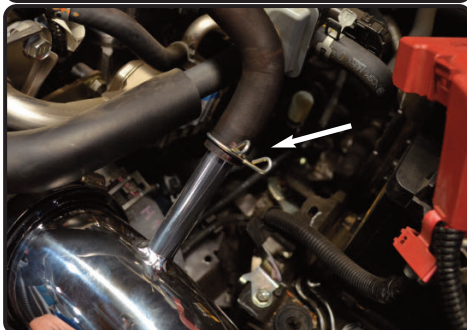

**22.** Re-connect the crankcase line to the 5/8" fitting on the intake tube. Secure using the OEM clamp.



**23.** Once positioned and adjusted properly, secure the intake tube to the urethane hose. Tighten all clamps using 8mm nut driver.

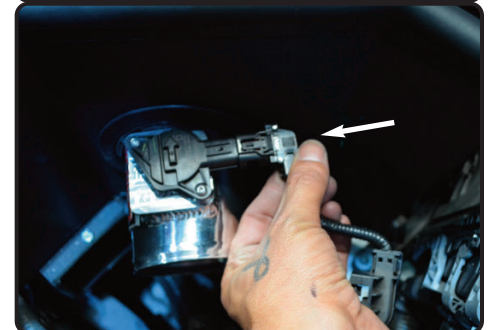

**24.** Re-connect the MAF sensor harness.

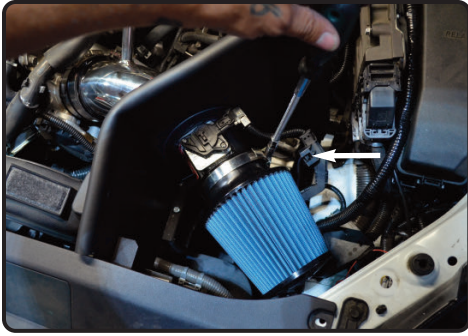

25. Install the air filter to the intake tube and secure using 8mm nut driver.

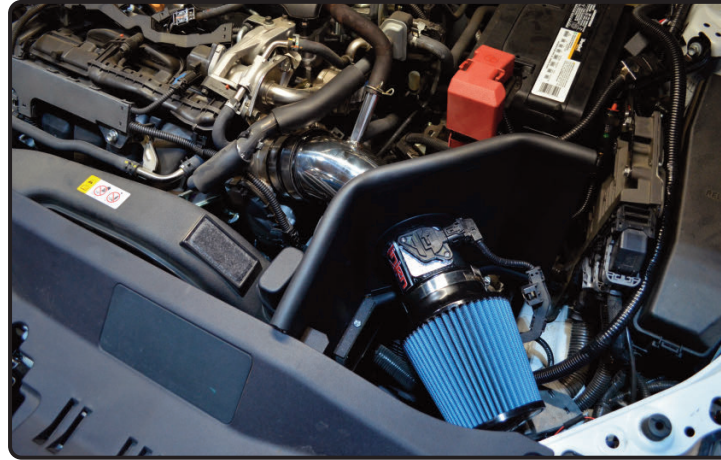

Congratulations! You have just completed the installation of this intake system. Periodically, check the alignment of the intake, normal wear and tear can cause nuts and bolts to come loose. **Note: Check clearance and adjust if needed! Failure to check the alignment and adjust the intake can cause damage that will void the warranty. Injen Technology is not responsible for any damages caused by/from improper installation.**

## Test Drive:

1. With the transmission in neutral or park and the parking brake engaged, start the engine. Listen for air leaks or odd noises. If air leaks are detected, secure hoses and connections. For any odd noises, inspect entire system for cause and adjust intake as needed. The Injen intake will function identically to the factory system but will be louder and more powerful.
2. Perform a road test. Listen for odd noises or rattles and fix as necessary.
3. If there are no issues, continue to enjoy your added performance from the Injen performance Intake kit.
4. Injen Technology recommends you periodically check clearance and adjust if needed! Failure to check the alignment and adjust the intake can cause damage that will void the warranty. Injen Technology is not responsible for any damages caused by/from improper installation.

1. Upon completion of the installation, reconnect the negative battery terminal before you start the engine.
2. Align the entire intake system for the best possible fit. Once the intake has been properly fitted continue to tighten all nuts, bolts and clamps.
3. Periodically, recheck the alignment of the intake system and make sure there is proper clearance around and along the length of the intake. Failure to follow proper maintenance procedures may cause damage to the intake and will void the warranty.
4. Start the engine and listen carefully for any odd noises, rattles and/or air leaks prior to taking it for a test drive. If any problems arise go back and check the vacuum lines, hoses and clamps that maybe causing leaks or rattles and correct the problem.
5. Check the filter for excessive dirt build up. Clean or replace the filter with an original Injen filter (can be bought on-line at "injenonline.com"). Congratulations! You have just completed the installation of the best intake system sold on the market. Enjoy the added power and performance of your new intake system.