



INSTALLATION GUIDE

2021+ Ford Bronco 2.3L/2.7L Snorkel

SKU: MMAI-BR-21N

TABLE OF CONTENTS

- Pg 1** RESOURCES AND CONTACT INFORMATION
- Pg 2** EXPLODED VIEW
- Pg 3** IMPORTANT SAFETY INFORMATION
 - SUPPLIED PARTS
 - REQUIRED TOOLS
 - INSTALLATION INSTRUCTIONS
- Pg 14** DISPOSAL INSTRUCTIONS
 - WARRANTY INFORMATION

RESOURCES & CONTACT

-  **CALL 1-877-GOMISHI**
CUSTOMER SERVICE HOURS: MON-FRI 8:30AM-5:00PM EST
-  **MISHIMOTO**
-  **GOMISHIMOTO**
-  **MISHIMOTO**
-  **WEBSITE**
WWW.MISHIMOTO.COM
-  **ENGINEERING BLOG**
WWW.MISHIMOTO.COM/ENGINEERING

PARTS BREAKDOWN

PART NUMBER	DESCRIPTION	QTY
MM2427-01	SNORKEL ASSEMBLY	1
MM2429-01	BRACKET 1	1
MM4636	COUPLER	1
MM2436	ADAPTER 1	1
MM1325-16	110-130MM WORM GEAR CLAMP	2
MM2379	SNORKEL HEAD	1
MM2383	SCREEN	1
MM1298-425	4.25" T-BOLT CLAMP	1
MM1152-32	M4 FLAT WASHER	7
MM1174-13	LOCK WASHER	11
B4X0.7-8A	BOLT	4
MM2429-02	BRACKET 2	1
MM1152-23	M6 FLAT WASHER	2
BF8X1.25-16	M8 BUTTON HEAD FLANGED BOLT	1
MM1163-02	M8 FLANGED LOCKING NUT	1
MM1152-24	M6 FLAT WASHER	8
MM174-18	LOCK WASHER	8
B6X1.0-12A	M6 12MM BUTTON HEAD BOLT	8
MM1342-09	RUBBER CAP	1
MM2437	ADAPTER 2	1
B4X0.7-25	M4 BUTTON HEAD BOLT	3
MM1152-18	FLAT WASHER	4
B4X0.7-25	M4 BUTTON HEAD BOLT	4
MM1897	RUBBER PLUG	1

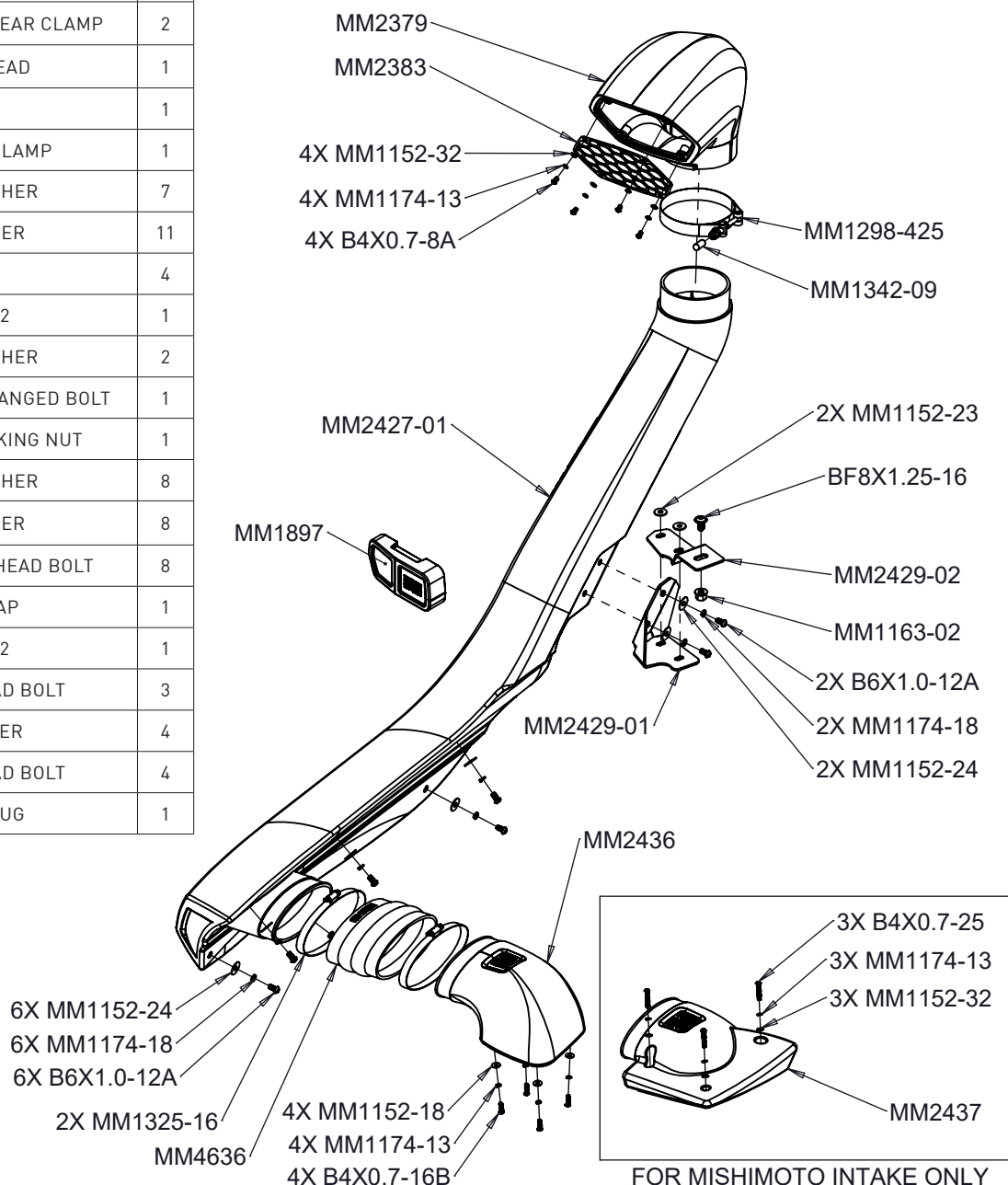

IMPORTANT SAFETY INFORMATION

- › Mishimoto recommends you use safety glasses and protective gloves during the installation of our products
- › Raise vehicle only on jack stands or on a vehicle lift
- › Allow vehicle to cool completely prior to attempting installation
- › Do not run the engine or drive the vehicle while overheating; serious damage can occur
- › Please dispose of any liquids properly
- › Mishimoto is not responsible for any vehicle damage or personal injury due to installation errors, misuse, or removal of Mishimoto products
- › If you need any assistance while installing our products, reach out to our Customer Service Team at 1-877-GOMISHI

REQUIRED TOOLS

ELECTRIC DRILL	TRIM CLIP TOOL
1/4" DRILL BIT	2.5MM ALLEN KEY
4" HOLE SAW	4MM ALLEN KEY
STEP DRILL	T25 TORX
CENTER PUNCH	T30 TORX
MASKING TAPE	1/4" RATCHET
SPRAY ADHESIVE	7MM DEEP SOCKET
SCISSORS	8MM DEEP SOCKET
MARKER	10MM DEEP SOCKET
PHILLIPS HEAD SCREWDRIVER	13MM DEEP SOCKET

INSTALL TIME: 4 HOURS

INSTALL DIFFICULTY: 

DISCLAIMER

The installation of a snorkel does not guarantee protection against water damage during extreme off-road and water-crossing activities for long periods of time. Various breather vents and delicate electrical components can be located above the manufacturer's recommended maximum water-fording line.

INSTALLATION INSTRUCTIONS

- 01.** Using a trim clip tool, remove the 9 pop clips. Remove the plastic tray.

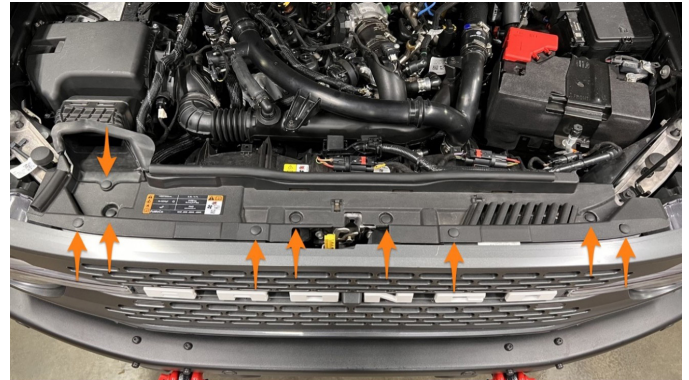

- 02.** Use a trim tool to release the tangs, then remove the air box duct.

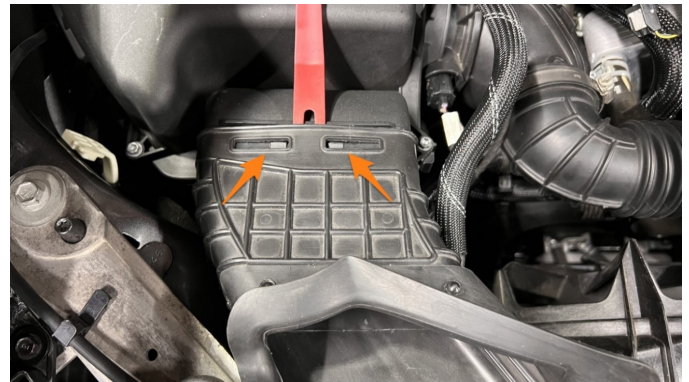

- 03.** If equipped, disconnect the front camera by using a pick tool to release the latch, then pull the connector apart. **Be careful, this connector is delicate.**



Continued on next page

04. If equipped, disconnect the washer hose by squeezing here and pulling apart.



05. Using a 10mm socket, remove the 4 screws.

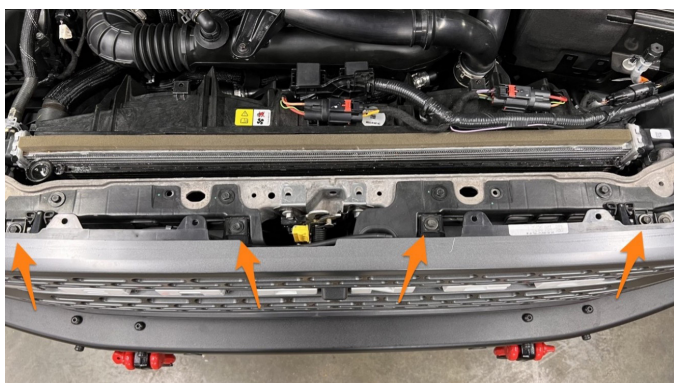

06. Remove the grille by starting at one end, popping the clips loose by pulling forward, and working across the bottom of the grille until all the clips are released.



07. On the passenger side of the vehicle, rotate the 5 lock levers a ¼ turn toward the wheel. Once the levers are disengaged, remove the fender flare by popping the clips loose, starting at one end and working your way down to release the rest.



08. On the driver side, disengage the first two levers (toward the front) and pop the front of the fender flare loose.



Continued on next page

09. Remove the front valance panel by pulling outward as shown to release the clips, then work around the front popping the clips loose until the panel is completely free.



10. If equipped with rock sliders, the passenger side slider will need to be removed in order to access the bottom bolts for the fender. At the three locations shown below, use a 10mm socket to remove the two nuts (a) and a 13mm socket to remove bolt (b).

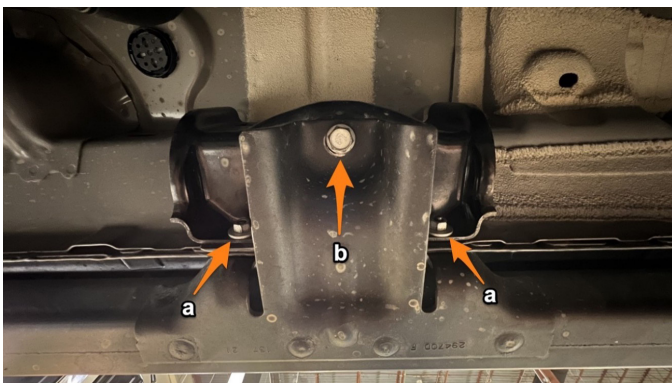

11. Once all the mounting hardware has been removed, lift on the rock slider (1) and pull away from the vehicle to remove (2).

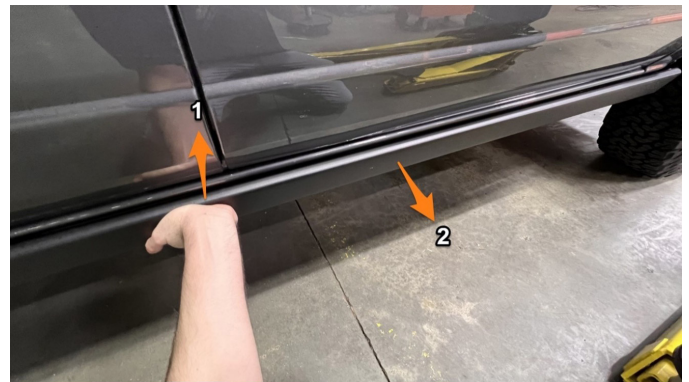

12. Next, the passenger side door will need to be removed. Push on the cover (a) and pull the connector (b) out.

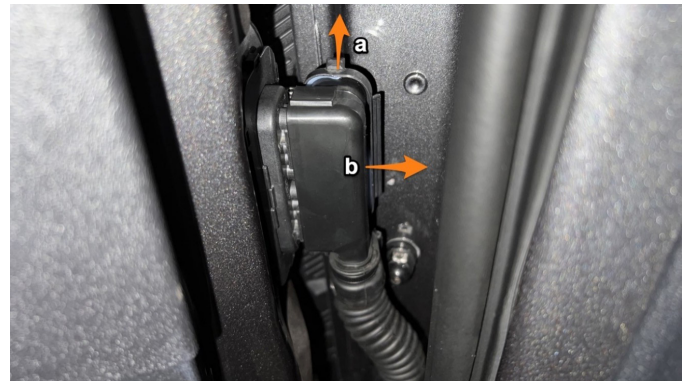

13. Using a 13mm socket, remove the two bolts.



Continued on next page

14. Remove the door by first lifting it up (1) and then moving it outward (2)



15. There are 5 clips located on the fender liner that needs to be removed.



16. To remove these clips, use a Phillips head screwdriver to turn the plastic screw about 1/4 inch out. Apply just enough force to keep the driver in the head of the screw while turning. If too much pressure is applied, the screw will not thread out.



17. Once loose, use a trim tool to pry the clips out.



18. There are 3 screws located on the fender liner that needs to be removed.



19. Using an 8mm socket, remove the 3 screws.

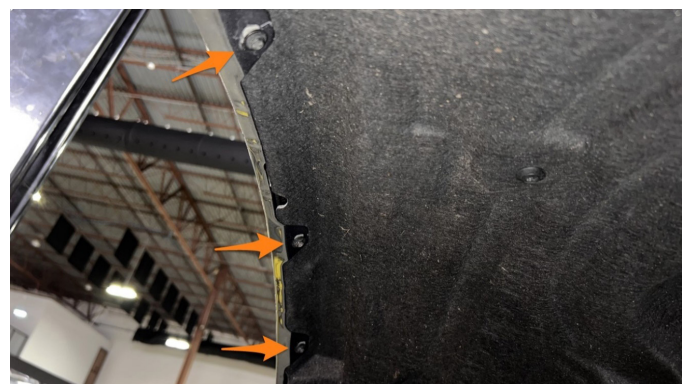

Continued on next page

20. Using a 10mm socket, remove the 3 screws and the plastic bracket.



21. Using a 10mm socket, remove the screw that was behind the bracket.



22. Using a 10mm socket and trim tool, remove the 3 screws and 4 clips. Next, pull out the cover panel.



23. Using an 8mm socket, remove the upper screw, then use a 10mm socket to remove the 3 lower screws.



24. Using a 10mm socket, remove the 2 nuts.



25. Using a 10mm socket, remove the 3 screws.

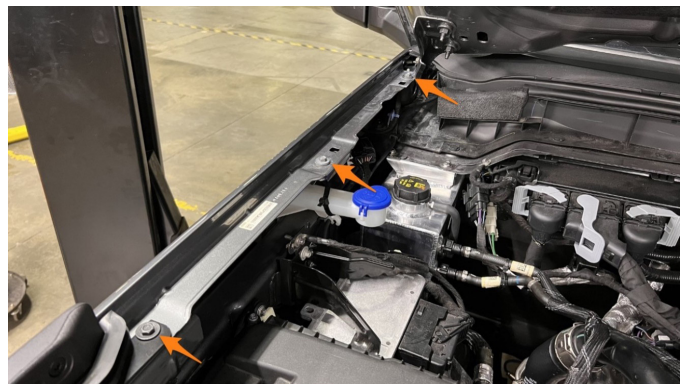

Continued on next page

26. Remove the bracket.



27. Using a 10mm socket, remove the screw that was under the bracket.



28. The fender can now be removed by pulling straight away from the vehicle. Be careful not to damage the small tab near the mirror while removing it.



29. If installing the snorkel with a stock intake, the airbox lid must be removed for modification. If installing with a Mishimoto intake, skip to step 39. Use an 8mm socket to loosen the 4 screws until the threads are just visible. The screws do not need to be removed completely. Remove the lid and set aside.

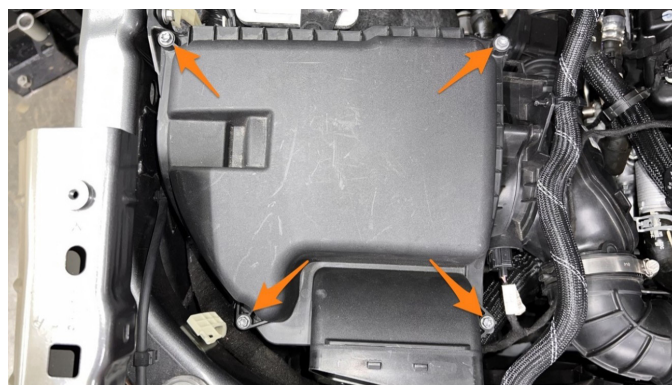

30. Lay out the fender template and check the printing scale using a ruler.

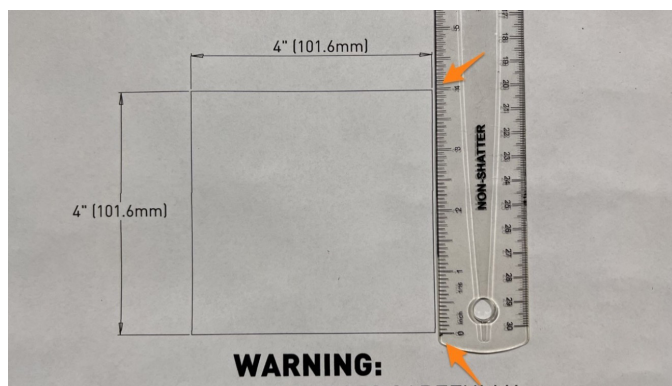
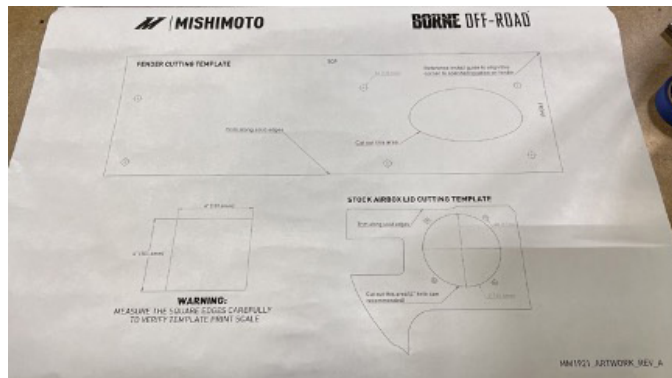

Continued on next page

31. Once the correct scale is verified, use scissors to cut out the airbox lid cutting template.

32. Lay the template on the airbox lid as shown. Ensure the template is centered from all edges of the lid, then secure it with masking tape.



33. Using a center punch, mark the center of the large circle and the 4 small surrounding holes.

34. Use a 1/4" drill bit to drill out the 4 holes and the center of the large hole. This will be a pilot for the hole saw.

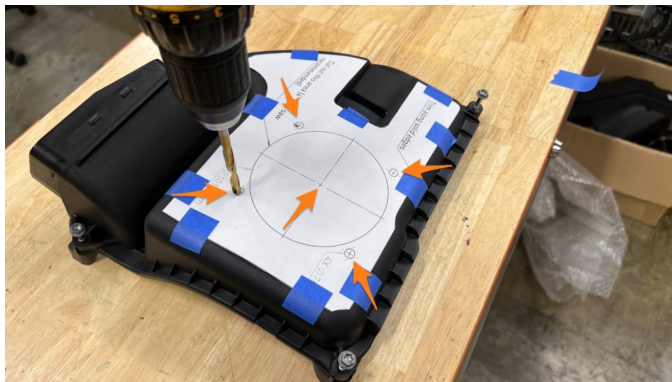

35. Firmly hold the airbox lid and use the 4" hole saw to cut the large center hole out. (Image on top right)



36. Once all the holes are drilled, remove the template. This is how the lid should look now.



37. Position adapter 1 MM2436 on top of the lid as shown.



Continued on next page

38. Using a 2.5mm Allen wrench, fasten the adapter to the lid with the supplied M4 hardware (see parts diagram). Proceed to step 40.



39. Using a 2.5mm Allen wrench, remove the 3 screws and clear lid from the Mishimoto intake.

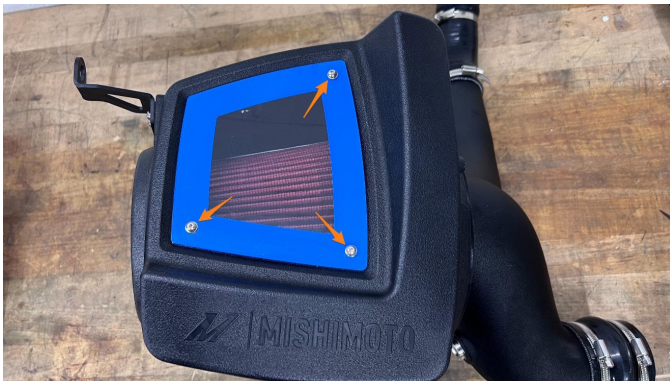

40. Next will be the fender modification. A note on the alignment of the fender template, this corner of the template (a) and "front" edge must line up with this edge (b) of the rectangular hole on the fender. Make a mark on the fender at point (c), collinear (orange line) with the long edge of the rectangular hole. Proper alignment of the template on the fender is critical to proper fitment of the snorkel.

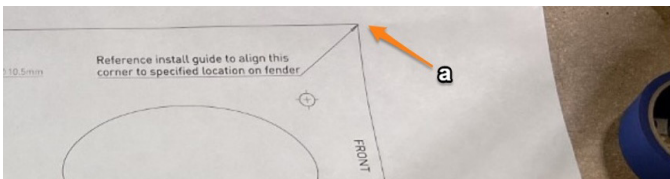

[Additional image on top right]

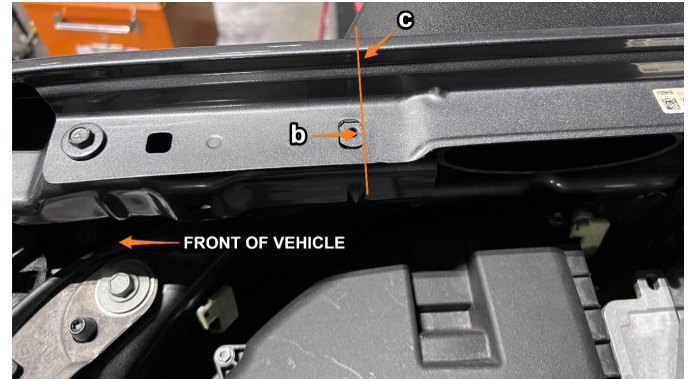

41. Cut out the template and lay it on the outside of the fender. Position as described in the previous step and mark the outline. Remove the template and cover the fender in masking tape over the template outline. The tape should extend roughly an inch beyond the outline of the template. The tape is to create a protective layer, so that the template won't stick directly to the painted surface of the fender and leave unwanted adhesive residues in the next step.



42. Coat the unprinted side of the template with a mild adhesive, like the 3M Super 77 spray adhesive or glue stick. Align the marked corner and front side of the template (a) with the mark made in the previous step (b).

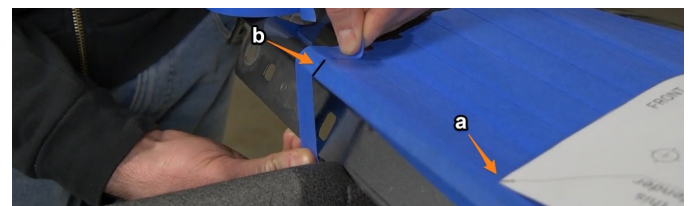

Continued on next page

43. Align the “TOP” edge of the template with the sharp bend on the top of the fender closest to the hood on the vehicle (where it makes a 90-degree bend). Press down the top edge to adhere it, then work from the top edge to press down the template onto the fender.

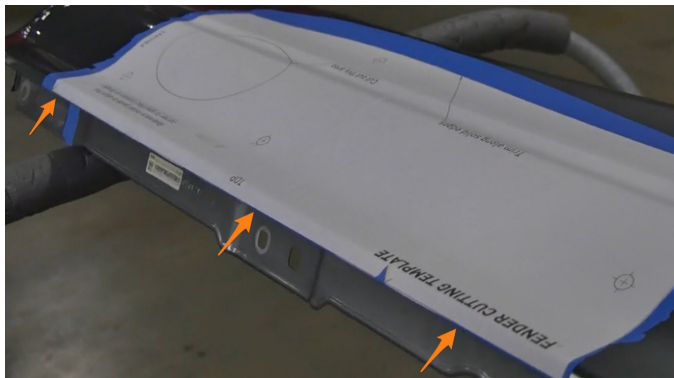

44. Important! You want to align the edge of the template to edge (a) not edge (b).

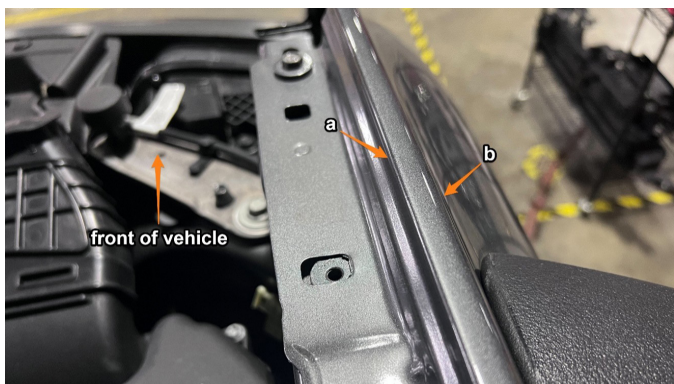

45. Use a center punch to mark the centers of the 6 mounting holes on the template, then use a step drill to open the holes to the size on the template (about 7/16”). Use the step drill to create a pilot hole for cutting out the oval in the next step.

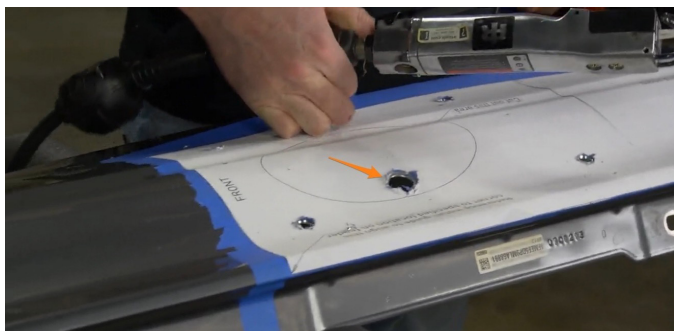

46. Starting in the pilot hole, use a body saw to cut out the oval on the template. Once all the holes have been cut out, break all the sharp edges with a file or deburring tool, then remove the template and tape from the fender.



47. Lay the snorkel MM2427-01 with an oval tube and brass thread inserts facing up. Place the fender onto the snorkel as shown and line up the drilled holes with the thread inserts on the snorkel. Using a 4mm Allen wrench, fasten the snorkel to the fender with the supplied M6 hardware (see parts diagram).



48. Reinstall the fender with snorkel onto the vehicle and reverse steps 1 through 28.

49. Using a T25 and T30, remove these two bolts.



Continued on next page

50. Using a 4mm Allen wrench, install bracket MM2429-01 (a) to the snorkel using the supplied M6 hardware (see parts diagram). Reinstall the stock Torx bolts (c) with the provided flat washers MM1152-23. There is an optional bracket provided MM2429-02 if installing lights that use these mounting points. If using this bracket, it installs on top of bracket (a).

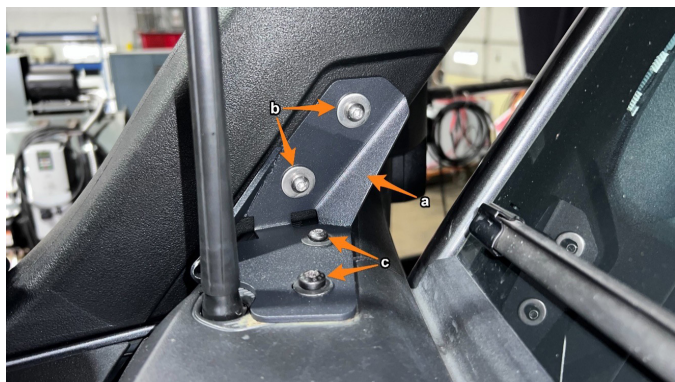

51. Install coupler MM4636 onto the snorkel tube and slide 2 of the worm gear clamps MM1325-16 on. Using a 7mm socket, tighten the clamp on the snorkel side.



52. If using the stock airbox, remove the airbox from the vehicle to better access the bolt right underneath the lip of the adapter.



53. Reinstall the stock airbox assembly with the adapter inserted into the silicone coupler. Tighten the worm gear clamp. **If using a Mishimoto intake, skip to step 54. Skip to step 55.**



54. Install adapter 2 MM2437 into the coupler and onto the Mishimoto airbox. Using a 2.5mm wrench, fasten with the supplied M4 hardware (see parts diagram). Tighten clamp (a).



55. The stock air duct can be used in addition to the snorkel in street applications. For off-road applications where water fording is possible, the air duct rubber cap MM1897 must be installed to pull air from the snorkel only. Note: When water-fording, the entire intake system must be sealed to ensure water does not enter the engine and cause irreversible damage. It is recommended to seal all drainage holes and seams on the airbox with RTV or other waterproof silicone sealant. **(Image on next page)**

Continued on next page



56. Install screen MM2383 onto snorkel head MM2379 with the supplied M4 hardware (see parts diagram). Slide t-bolt clamp MM1298-425 over the collar on the snorkel head.



57. Install the snorkel head onto the snorkel and use a 10mm socket to tighten the clamp.



58. Torque all fasteners to the manufacturer's recommended specifications.

Congratulations! Your installation is now complete!

DISPOSAL INSTRUCTIONS

- › Do not dispose of any product as unsorted municipal waste. Use separate collection facilities. Contact your local authority for information regarding the collection systems available.
- › Never improperly dispose of any coolant, oil, or other chemicals.

WARRANTY INFORMATION



- › All claims must be accompanied with a picture of the Mishimoto product showing the issue for which the claim is being submitted.
- › Mishimoto asks that the customer inspect their purchased item for any damage immediately upon arrival.
- › Any product deemed dead on arrival (DOA) must be claimed within 14 business days of delivery. Claims outside of this time frame will not be covered under the Mishimoto Lifetime Warranty.
- › This warranty does not include payment and/or reimbursement of the cost of labor in connection with the removal of any product returned pursuant to the warranty policy or in connection with the installation of any replacement items provided under the warranty policy.
- › Mishimoto has the right to refuse a claim at any time.

- › When Mishimoto accepts a claim, Mishimoto retains full discretion to choose if it will: (i) repair or replace purchaser's original Mishimoto product; (ii) replace purchaser's original Mishimoto product with the most current available model; or (iii) provide the purchaser with a gift card redeemable on [Mishimoto.com](https://www.mishimoto.com) in the amount of the original purchase price of the original Mishimoto product. The provision of a replacement of a Mishimoto product is subject to availability and Mishimoto retains the right to substitute any warranty claim item with a comparable item or credit at any time.
- › If Mishimoto determines that it will provide a replacement item in connection with a claim under this warranty policy, and such item is out of stock, Mishimoto will place the customer on backorder and ship the replacement product to the purchaser once it becomes available.
- › Mishimoto is not liable for incorrect shipments in connection with a claim if a claim form is completed incorrectly, or if a model number is not included in a claim.
- › If you have a vehicle equipped with an automatic transmission, please make sure to specify this within the text box on the claim form. Mishimoto is not responsible for incorrect replacement shipments if transmission type is not indicated.



WARNING
Cancer and
Reproductive Harm
www.P65Warnings.ca.gov

This product can expose you to chemicals which are known to the state of California to cause cancer. For more information visit: www.p65warnings.ca.gov